

# Understanding Generator Ripple Waveforms

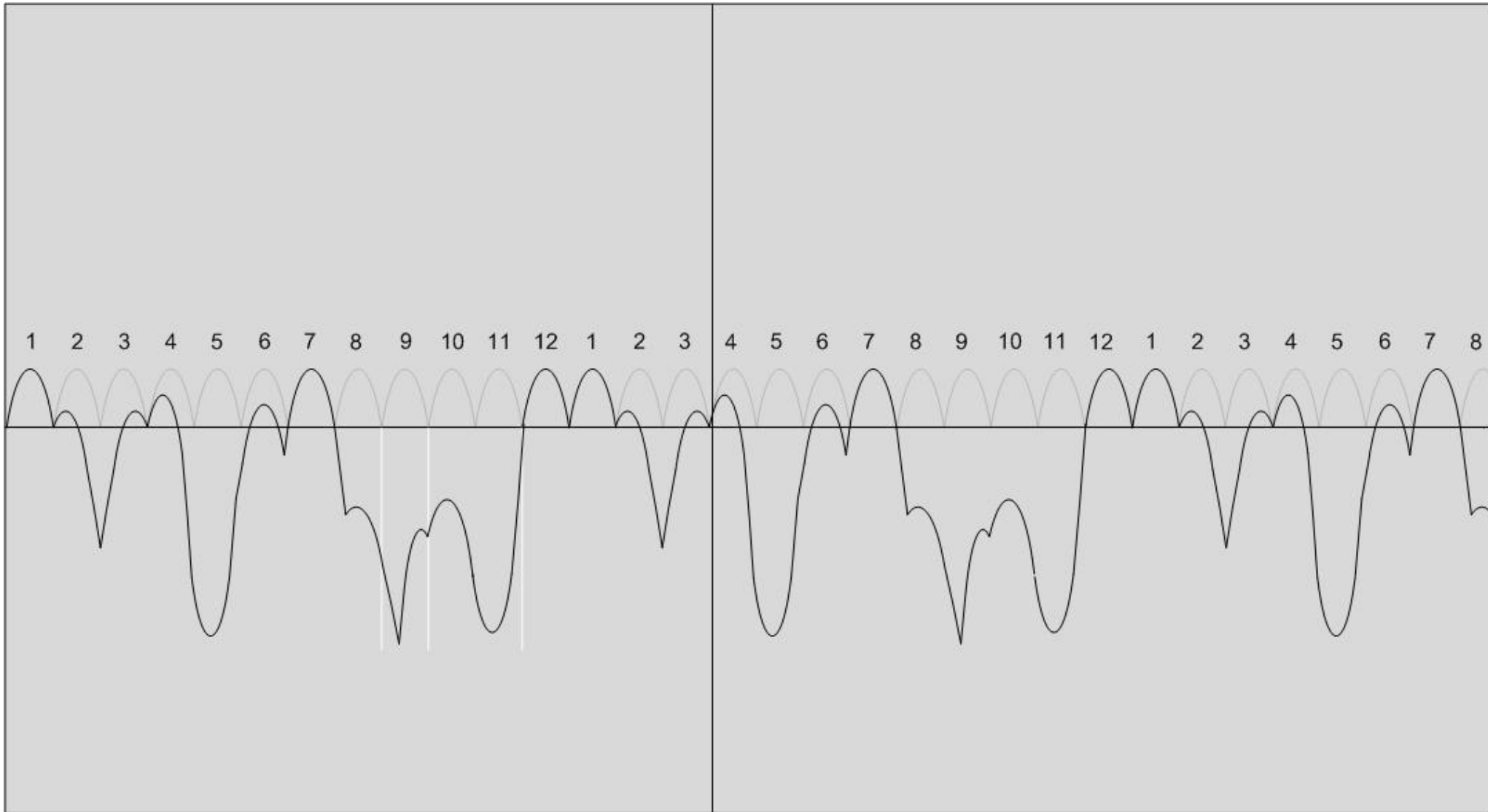

# Understanding Generator Ripple Waveforms

## Table of Contents

<b>Chapter</b>	<b>Page</b>
<b>Preliminary Information and Setup</b>	<b>3</b>
<b>Generator Theory</b>	<b>6</b>
<b>Generator Ripple Theory</b>	<b>15</b>
<b>Factors that Influence the Appearance of Normal Generator Current Ripple</b>	<b>23</b>
<b>Examples of Normal Current Ripple Waveforms</b>	<b>30</b>
<b>Examples of Faulted Current Ripple Waveforms</b>	<b>37</b>

## Preliminary Information and Setup

The alternator ripple test is designed primarily to verify the proper operation of the rectifier diodes by monitoring the current waveform for the characteristics of a bad diode or open phase winding. The waveforms can be very complex. Initial evaluation by monitoring voltage ripple can be misleading. Do not condemn any components until after evaluating the current ripple. Current ripple provides the necessary detail to make an accurate determination of component condition.

The following document will explain how to evaluate waveforms and determine if a fault exists. Example patterns are provided in later sections with additional explanation. From this point forward, the term "generator" will be used in place of the word "alternator" according to SAE standards.

Prior to performing a generator ripple test, verify basic charging system integrity including electrical connections, accessory drive belt condition and tension, and battery health. **Note: It is very important that all electrical connections between the generator and battery are verified to be clean and tight.** These items can affect the waveform and lead to misdiagnosis if not corrected prior to viewing the signal.

When performing the generator ripple test, the following conditions should be met:

- engine at base idle speed
- battery in good health
- charging system under moderate load (such as the headlamps and heater blower turned on)

When loading the charging system, resistive loads such as lights and the rear window defrost grid are preferred over blower motors and inductive loads that might generate electrical noise in the vehicle's wiring harness. Test the generator ripple at 40-60% of the generator's output or whatever charging system load is required to duplicate a fault.

Certain faults may only appear during heavy charging system load. It is possible that the total current being produced by the generator will be greater than what the 50 amp current probe can measure. This will result in the oscilloscope trace either flat-lining the tops of some ripple pulses or the oscilloscope trace dropping to 0. An example illustration of this is provided later in the document. Switch to the 500 amp probe when testing the generator at greater than 50 amps output.

If the vehicle is equipped with dual generators, test only one at a time. Be sure to locate the current probe on the generator B+ output wire prior to any splices with other positive cables and disable the other generator by disconnecting its electrical connector for the regulator.

4

Connect the 50 amp current probe to the generator B+ output wire being sure that the arrow on the probe jaws points in the direction of conventional current flow to the positive battery terminal. (See figure 1.) Choose "Alternator Ripple Test" from the Toolbox >> Oscilloscope Tools menu of IDS. Click within the Hookup 2 instructions for the 50 amp current probe and choose the blue tick.

**Figure 1**

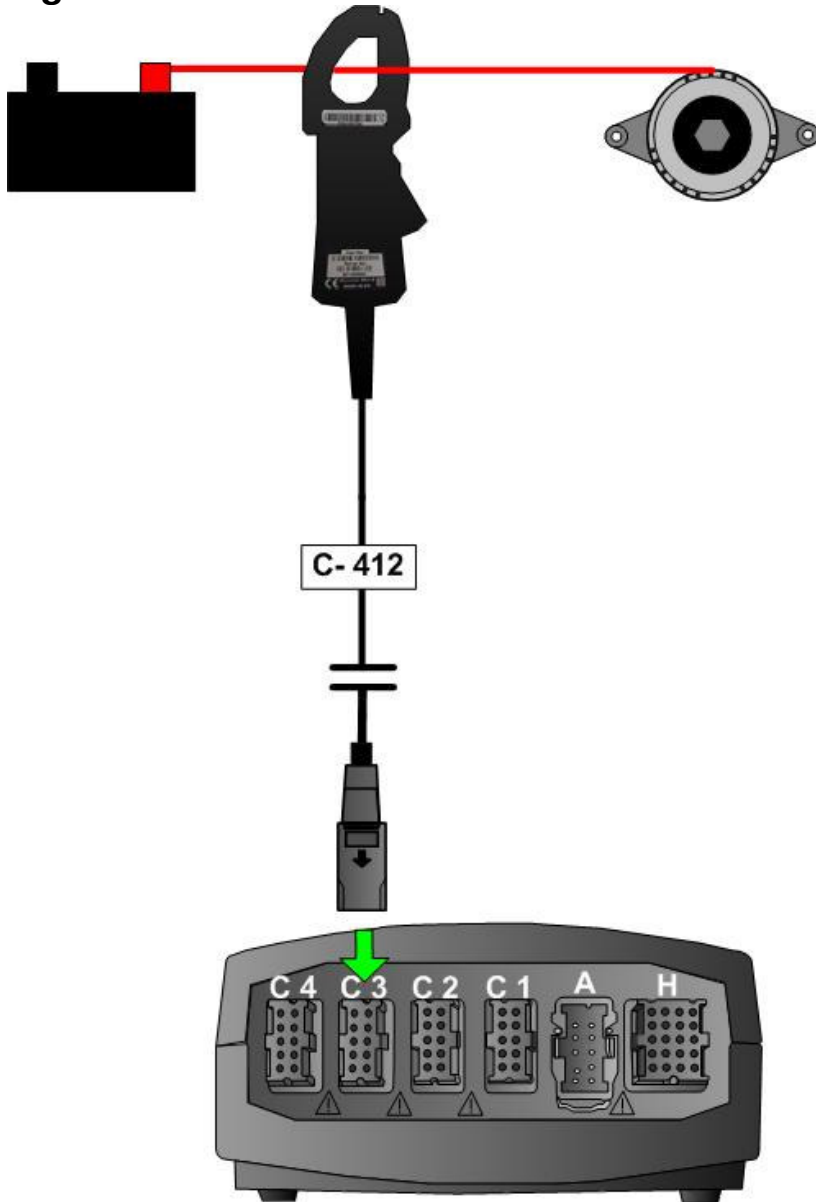

The oscilloscope will automatically be configured with the following settings:

Channel 3

Manual

Sense – 50A Probe

Scale – 2 amps/div

Coupling – AC

Time Base

Scale – 2 ms/div

If it is necessary to use the 500 amp probe, manually change the settings to the following:

Channel 3

Manual

Sense – 500A Probe

Scale – 5 amps/div

Coupling – AC

Time Base

Scale – 2 ms/div

# Generator Theory

The generator produces an alternating current (AC) through the principle of electromagnetic induction. When a magnetic field is passed through a conductor, an Electromotive Force, EMF is generated in the conductor. The EMF, measured in volts will produce current flow in the completed circuitry of the generator. The AC current is rectified with internal diodes and a near-constant direct current, DC potential is generated.

The generator consists of the following components;

- stator windings and armature
- rotor or field windings, armature, and slip rings
- diodes and rectifier assembly
- regulator, brushes, and connectors
- end frame and casing.

The stator windings are mounted stationary in the case and wound within an armature. It is in the stator windings that the output current of the generator is produced. The stator windings are wound in overlapping coils or bundles to generate a more consistent and efficient output. The rotor is a single coil wound within an armature assembly with connecting slip rings on the end. It is in the rotor where the field current produces the strong magnetic field responsible for the generation in the stator windings. The shape of the rotor provides multiple north and south magnetic poles.

The diodes of the rectifier assembly are responsible for internally converting the AC output of the stator to a DC output of the generator. The rectifier has multiple pairs of positive and negative connected diodes to accomplish the rectification of the multiple phase stator windings.

The regulator, brushes, and connections are responsible for controlling the rotor's field current which in part determines the strength of the magnetic field and the output of the generator. The regulator also monitors the vehicle battery voltage. In many current vehicle systems the regulator communicates with the PCM and responds to PCM commands in order to control the output of the generator.

The end frame and casing houses the components of the generator and acts as a heat sink to cool the generator. A number of factors influence the output of the generator, including the size and number of windings in the stator and rotor, the strength of the rotor's magnetic field and the speed which the rotor spins past the stator windings.

Stator phase windings can be connected in either a Wye or Delta configuration. Both produce 3 phase alternating current. An example schematic of each is provided in figure 2.

Figure 2

Wye Wound Stator (3 phase)

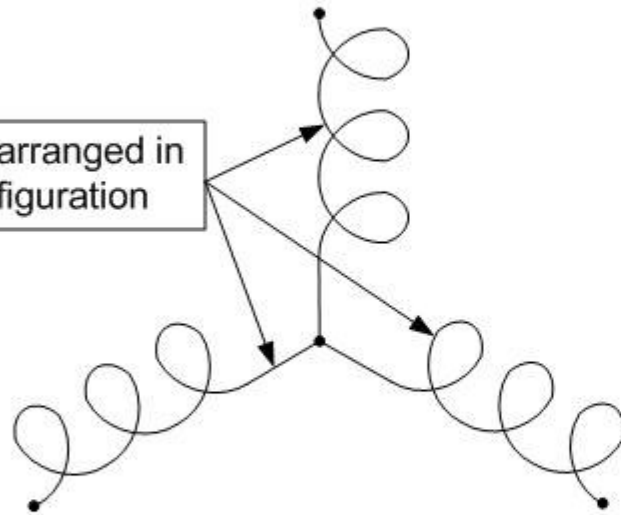

windings arranged in  
"Y" configuration

Delta Wound Stator (3 phase)

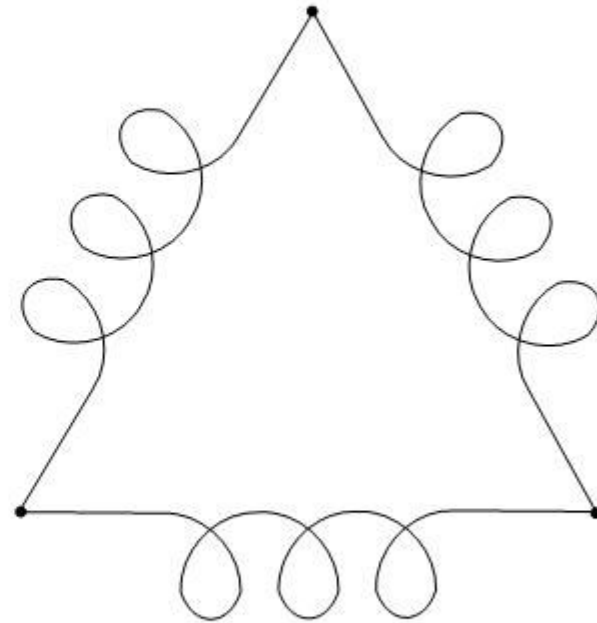

windings arranged in  
"Δ" configuration

When the generator is constructed, the stator phase windings are physically formed in the shape of a hollow cylinder and wrapped around an iron core called the armature. The stator windings and armature are attached to the inside of the generator case. The magnetic field responsible for generating electricity comes from the rotor. The rotor is an electromagnet which usually consists of 6 or 8 magnetic pole pairs. The rotor rotates within the hollow cylinder formed by the stator windings.

Figure 3 shows the connection scheme of each type of stator winding and the magnetic poles of the rotor. Within an actual generator, the stator windings overlap each other and are subdivided into groups which are positioned to take advantage of each rotor magnetic pole pair.

**Figure 3**

Wye Wound Stator  
with magnetic field of rotor

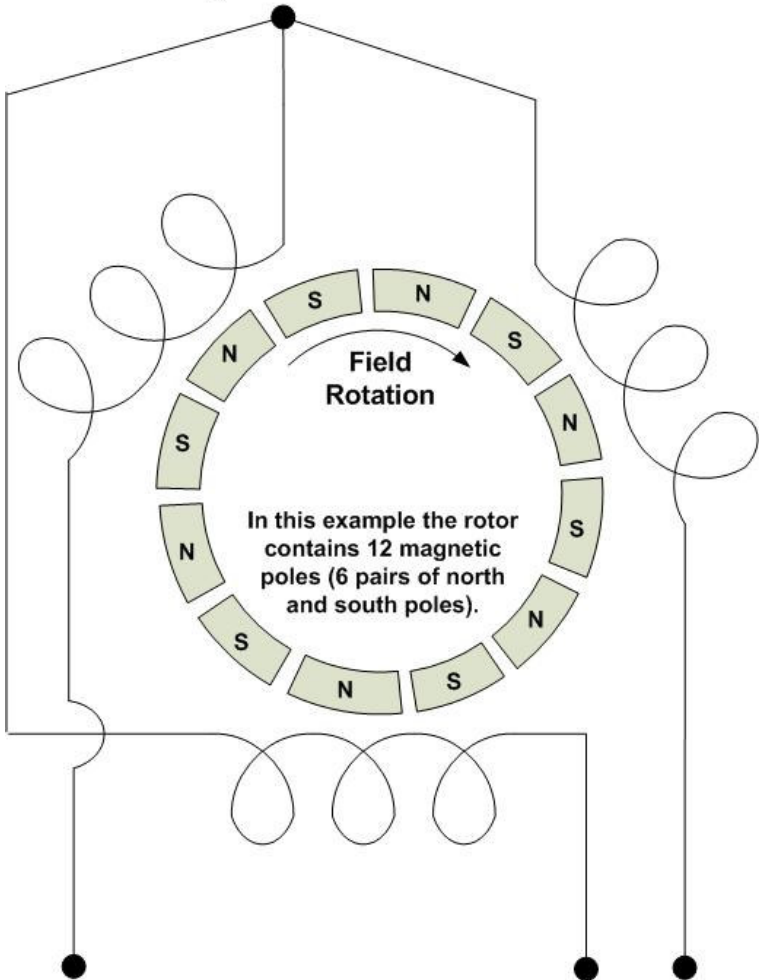

Delta Wound Stator  
with magnetic field of rotor

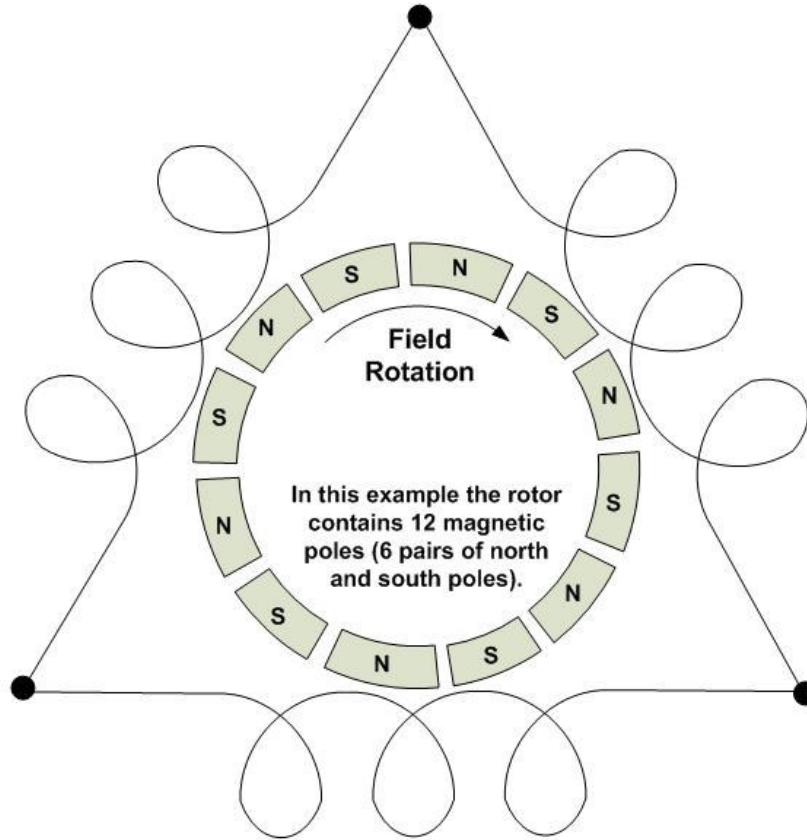

The rotor contains a coil of wire inside of two opposing "claw-shaped" iron pole pieces. The iron pole pieces are also referred to as an armature. The "claw-shaped" pole pieces provide north and south magnetic poles used to generate current in the stator windings. The regulator controls the strength of the magnetic field of the rotor by controlling the current flow into the rotor winding. This current flows into and out of the rotor via slip rings on the rotor shaft and brushes. Figure 4 illustrates a rotor and its magnetic equivalent.



**Figure 4**

**The field windings within the rotor form an electromagnet powered via the slip rings. The shape and construction of the rotor provides alternating north and south poles.**

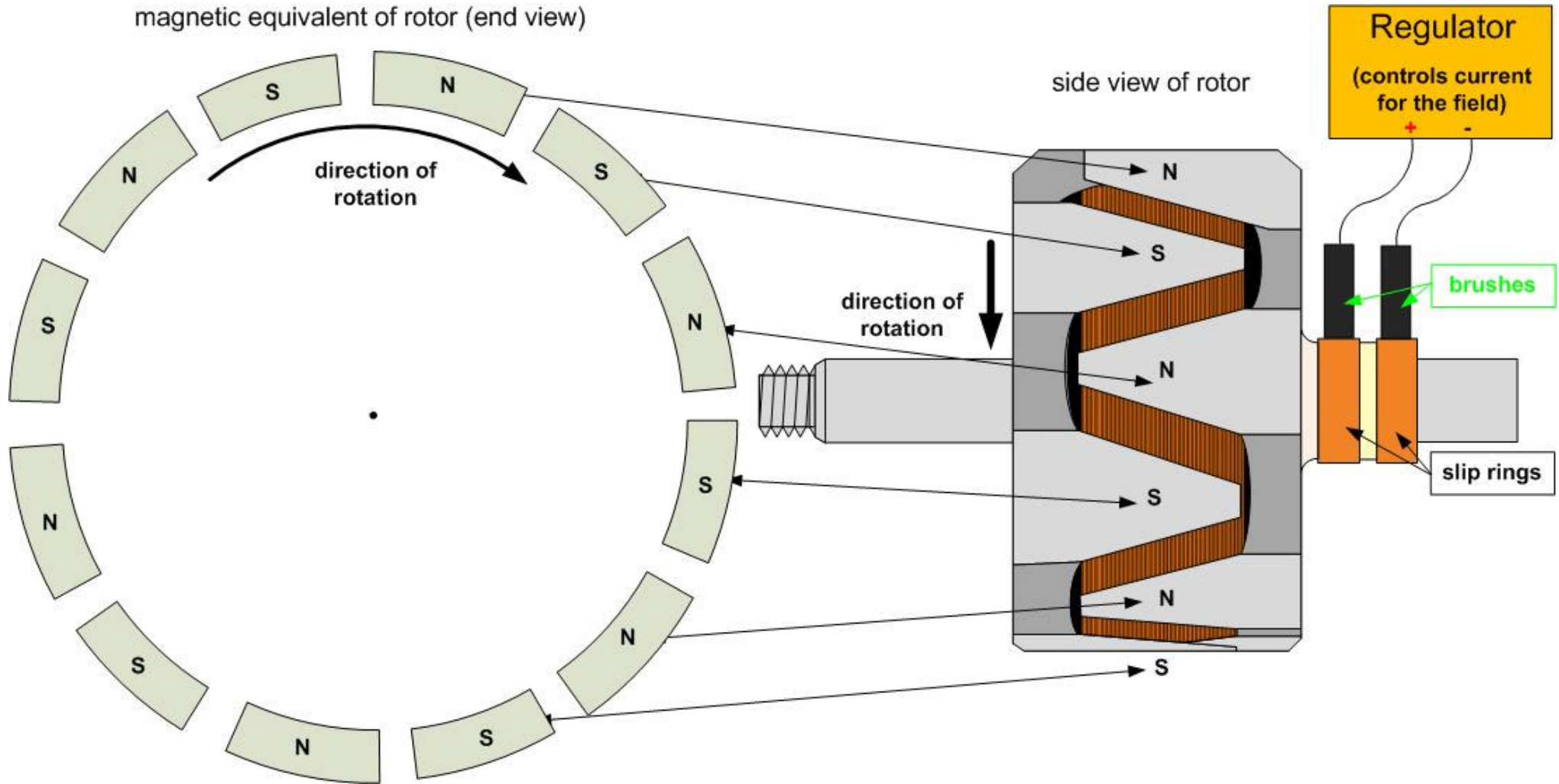

As the north and south poles of the field move past the stator windings, alternating current is generated. Each phase winding is connected to a pair of diodes. In figure 5, the delta winding schematic is illustrated with the six corresponding diodes.

**Figure 5**

### Delta Wound Stator With Diodes

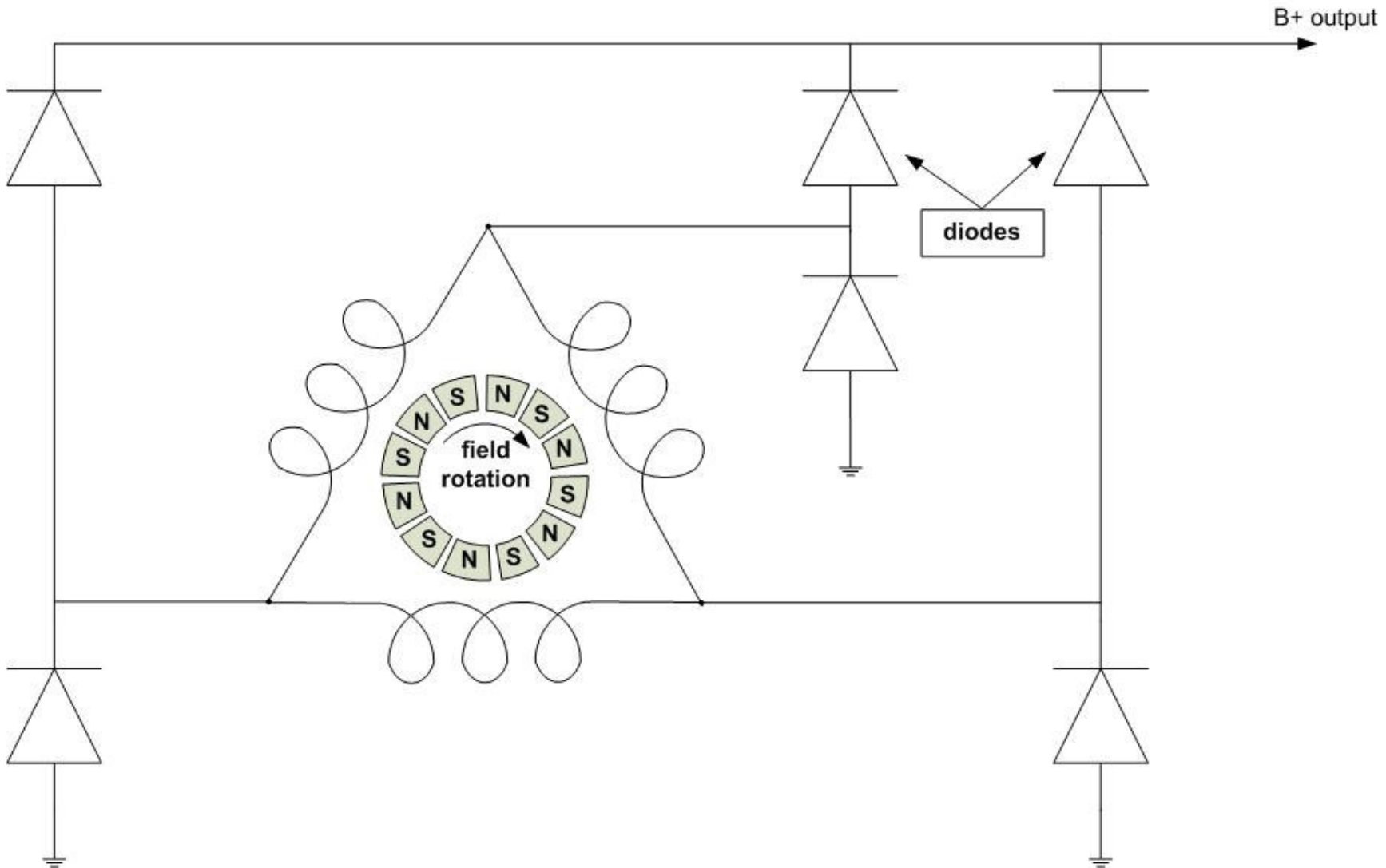

The output from each phase of the wye wound stator is also routed to diodes. The point where the three phases are connected together is called the neutral junction. On some generators the neutral junction is used only for the stator windings. On other generators, the neutral junction may be connected to an additional pair of diodes. Still other generators provide an external connection to the neutral junction so that the voltage may be used as a signal for the voltage regulator or other purposes. Figure 6 shows how an optional pair of diodes would be connected.

**Figure 6**

Wye Wound Stator With Diodes

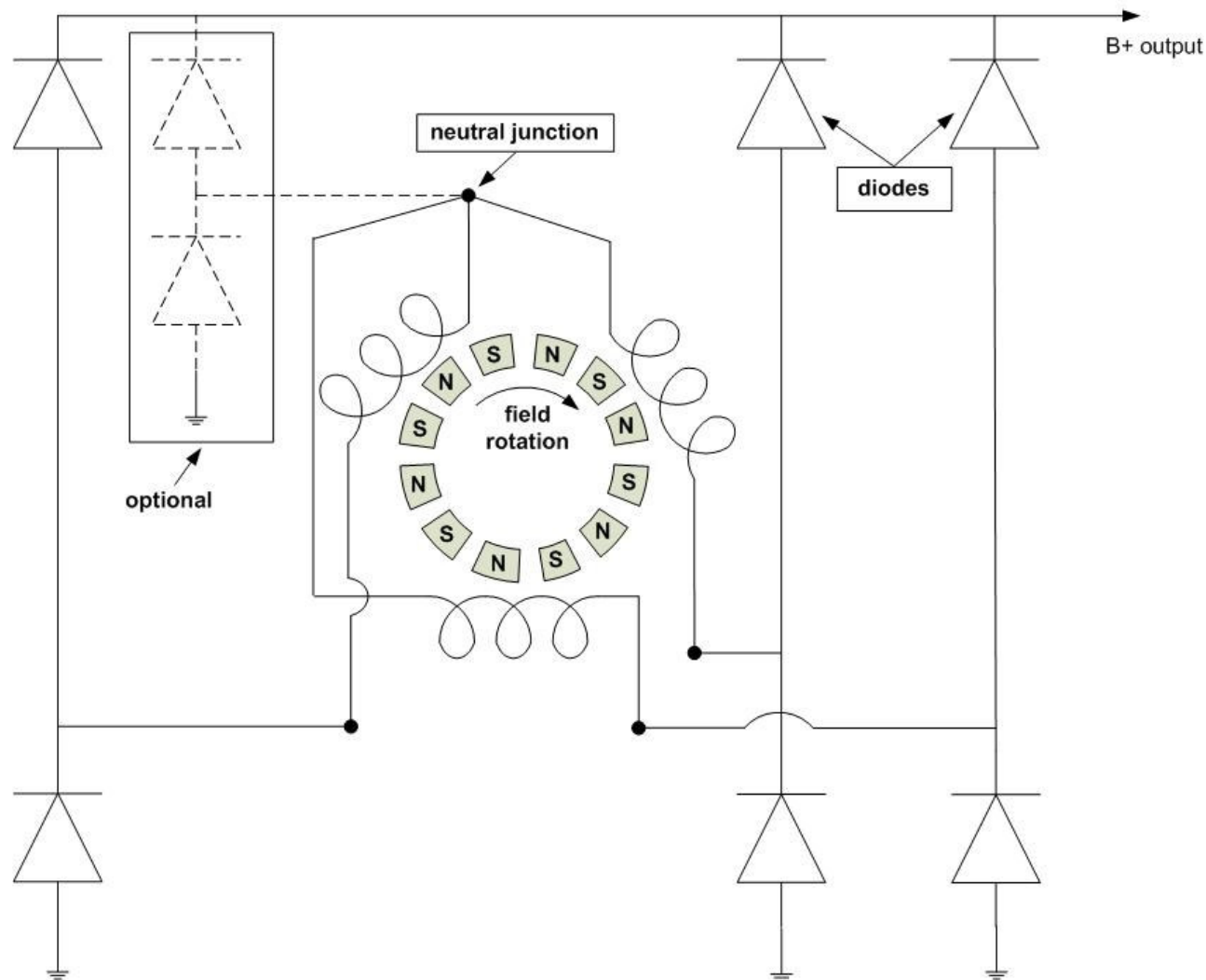

As the rotor turns, alternating current is generated in each phase winding. Because the current is generated first in one direction, then the other direction, diodes are used to rectify the alternating current to direct current. The delta wound stator is illustrated in figure 7.

**Figure 7**

### Delta Wound Stator

Diodes capture the current that flows in each direction through a phase winding.

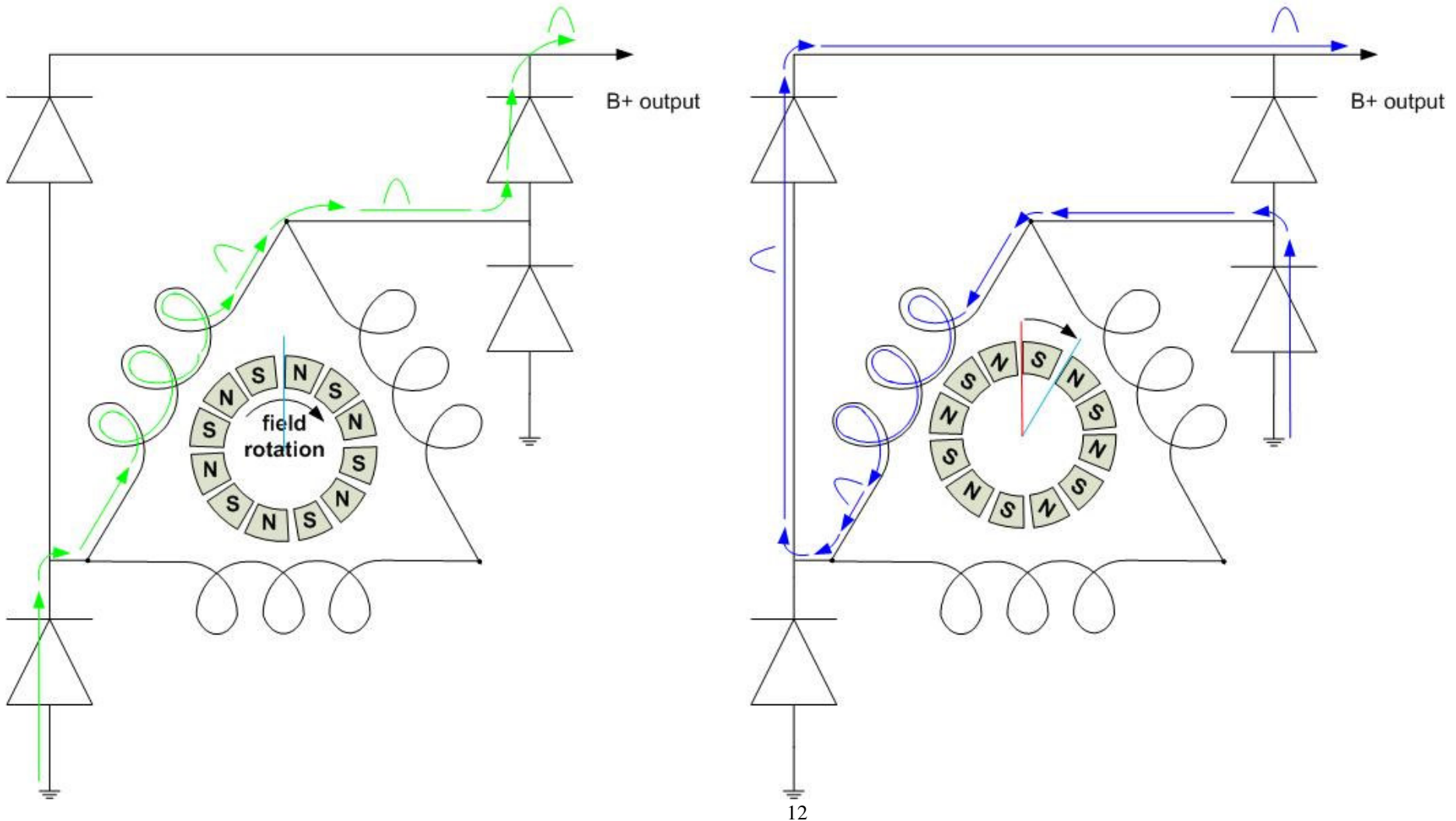

The wye wound stator is similar, however two windings always combine their outputs in series as illustrated in figure 8.

**Figure 8**

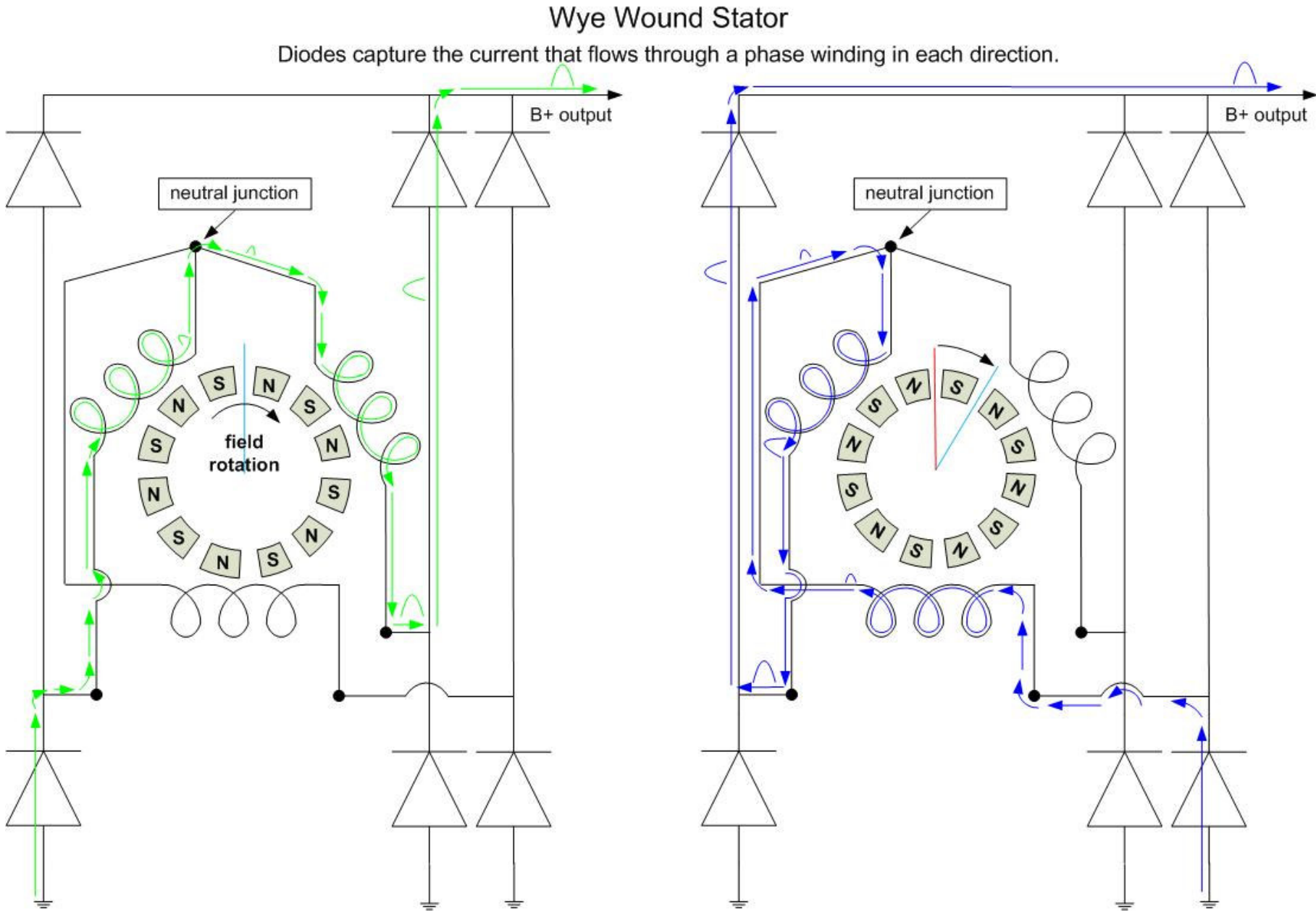

The construction of six phase generators may be thought of as two sets of three phase windings in the same physical housing. They may be constructed as a double delta, a double wye, or one wye plus one delta. Generator construction is not limited to only three or six phase windings. Other types and numbers of phase windings are possible.

Figure 9 is an example of a six phase generator schematic which uses one wye plus one delta for its stator windings. Green arrows indicate the direction of current pulses. Individual pulses are color coded and labeled to aid in matching them up from where they are produced to where they pass through a specific diode. Six diodes are connected to the B+ output line. Each allows two current pulses to pass. Actual generator operation produces evenly timed pulses as indicated by the theoretical diode current ripple pattern illustrated.

**Figure 9**

6 Phase Generator  
(1 wye + 1 delta)  
stator windings,  
diodes, and ripple  
pulses

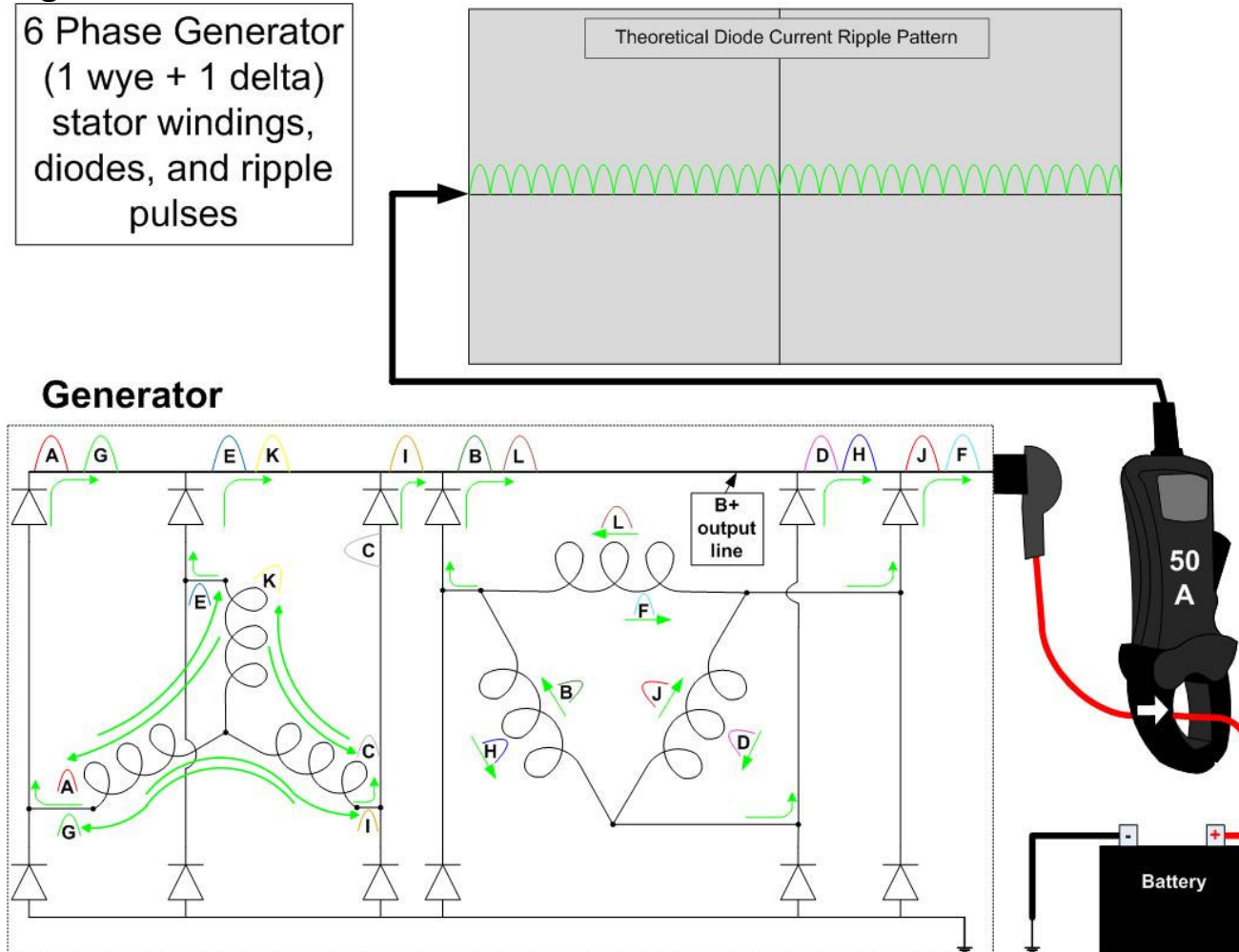

## Generator Ripple Theory

The critical information of interest is the ripple pattern created by the generator windings and diodes. In order to interpret the waveform, it is first necessary to identify what normal diode ripple looks like. The following explanations and illustrations show what a theoretical pattern would look like if the generator were driven at a perfectly constant speed with the regulator on 100% of the time with a constant electrical load. Further explanation is necessary and will be given regarding how the waveform is affected by normal vehicle operating conditions including engine RPM fluctuation, regulator switching, and varying vehicle electrical loads.

Theoretical diode current ripple (alone) is the waveform pattern in figure 10. A vehicle's waveform is influenced by other factors which will be discussed later in this section.

**Figure 10 Theoretical Diode Current Ripple With No Faults**

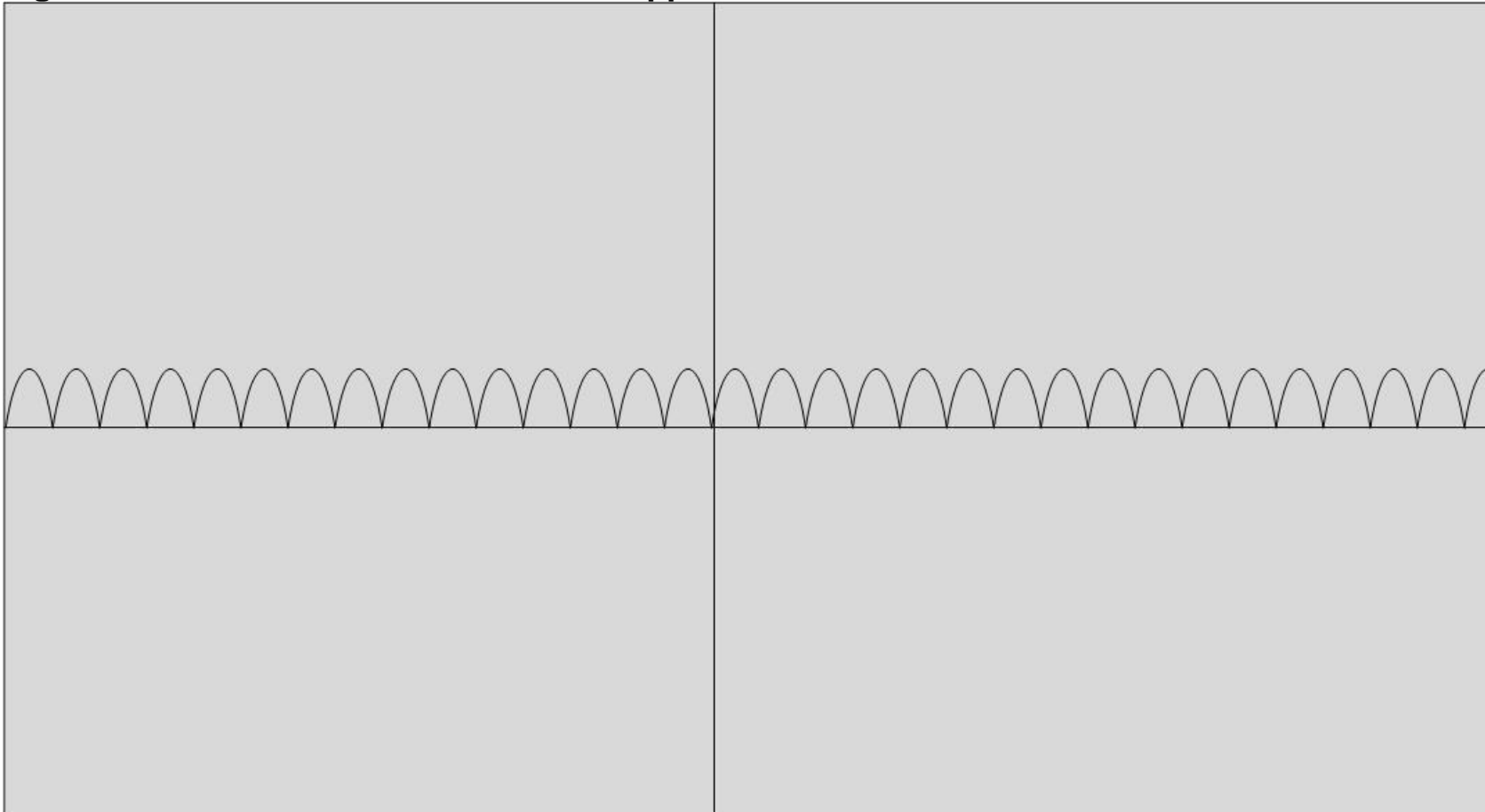

To visualize the number of current ripple pulses produced by the generator, review figure 11 and figure 12. The relationship of how diode current ripple pulses are produced in one generator revolution on a typical 3 phase generator is shown in figure 11. Note that this is a general illustration. Some 3 phase generators have 8 field pole pairs which would result in 48 pulses per revolution.

**Figure 11**

### 3 Phase Generator

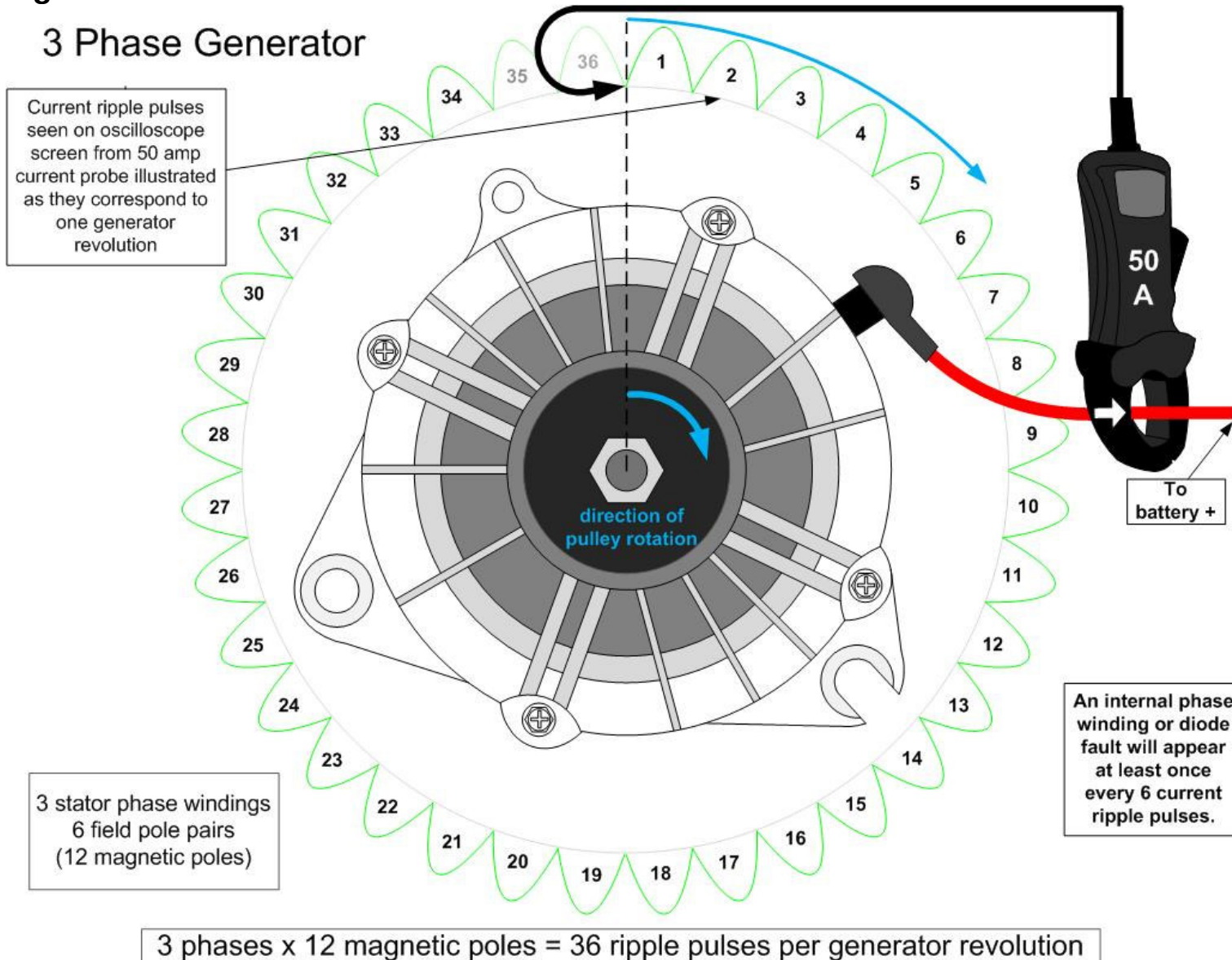
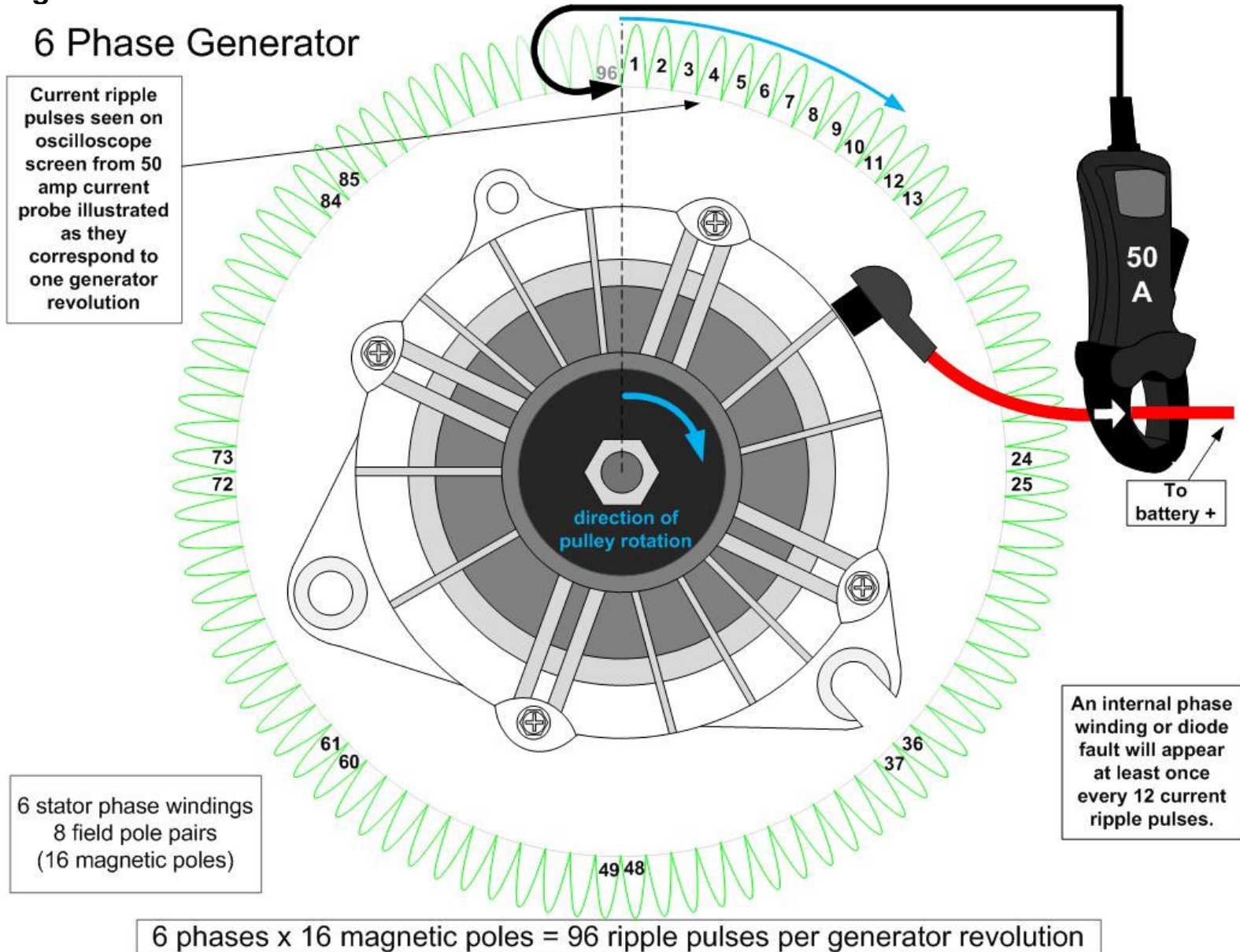



Figure 12 is an example of a 6 phase generator with 16 field poles. Again, this is a general illustration. Some 6 phase generators have 6 magnetic pole pairs which would result in 72 pulses per revolution. Other designs are possible as well.

**Figure 12**

**6 Phase Generator**



Next, the significant internal generator faults identifiable by viewing generator current ripple will be illustrated.

A faulted generator stator winding or diode will create a repetitive fault. In other words, the same number of ripple pulses will appear between every occurrence of the fault. Other electrical activity on the vehicle may appear randomly in the waveform, but will not be consistent. Knowing this difference is critical to distinguish between waveforms which indicate normal electrical activity from those which indicate an internal generator fault.

Each phase (winding) of the generator will produce two pulses as a magnetic field pole pair of the rotor (1 north and 1 south pole) moves past (approaches and departs). For example, a 3 phase generator will produce a pattern of 6 diode ripple pulses for each magnetic field pole pair. A 6 phase generator will produce a pattern of 12 diode ripple pulses for each magnetic field pole pair. The remaining illustrations will be given for a 6 phase generator.

If the diodes and phase windings are in good health, all of the diode ripple pulses will appear very similar in amplitude and duration. Unfortunately, this is not always easy to discern because of other normal signals which intrude upon a normal diode current ripple waveform. Examples of this will be covered later.

If there is an internal generator fault, it will be repetitive and can be identified by looking for a pattern of 12 diode ripple pulses which repeat on a 6 phase generator. (For a 3 phase generator the fault will repeat every 6 diode ripple pulses.) Examples are provided below to illustrate this on a 6 phase generator.

Figure 13 shows the effect of an open diode on a 6 phase generator. Only one diode was open, but the result is that two pulses are absent (#9 and #10). The waveform indicates how the #8 and #11 pulses are deformed and stretch toward each other until they are twice as wide in order to fill in the empty space. Note how the pattern of pulses has changed compared to figure 10. (The diode ripple pulses are numbered 1-12 for reference.) As shown in figure 9, each diode passes two current pulses, therefore it makes sense that one open diode removes two current pulses.

**Figure 13 Diode Current Ripple With One Open Diode**

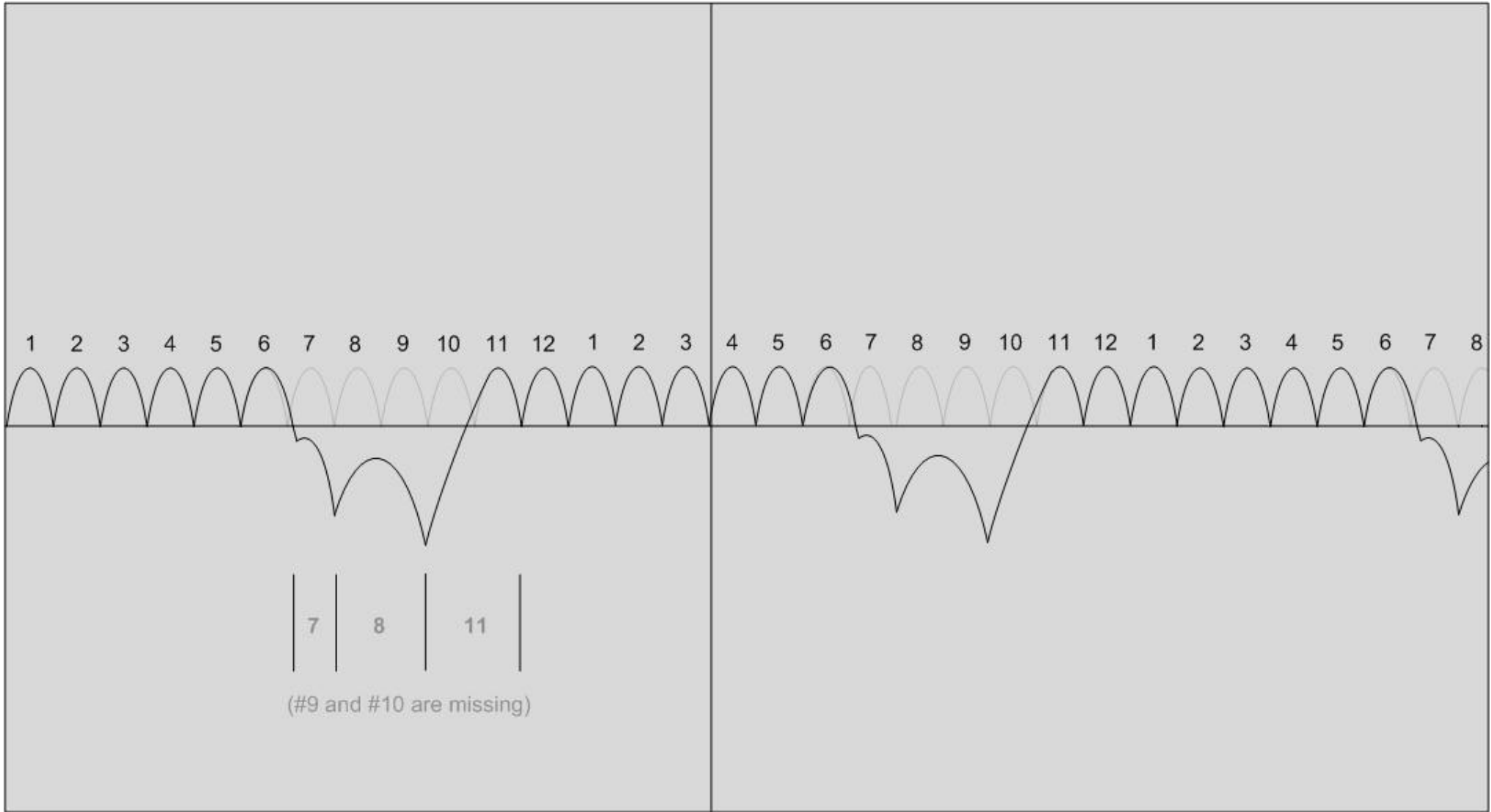
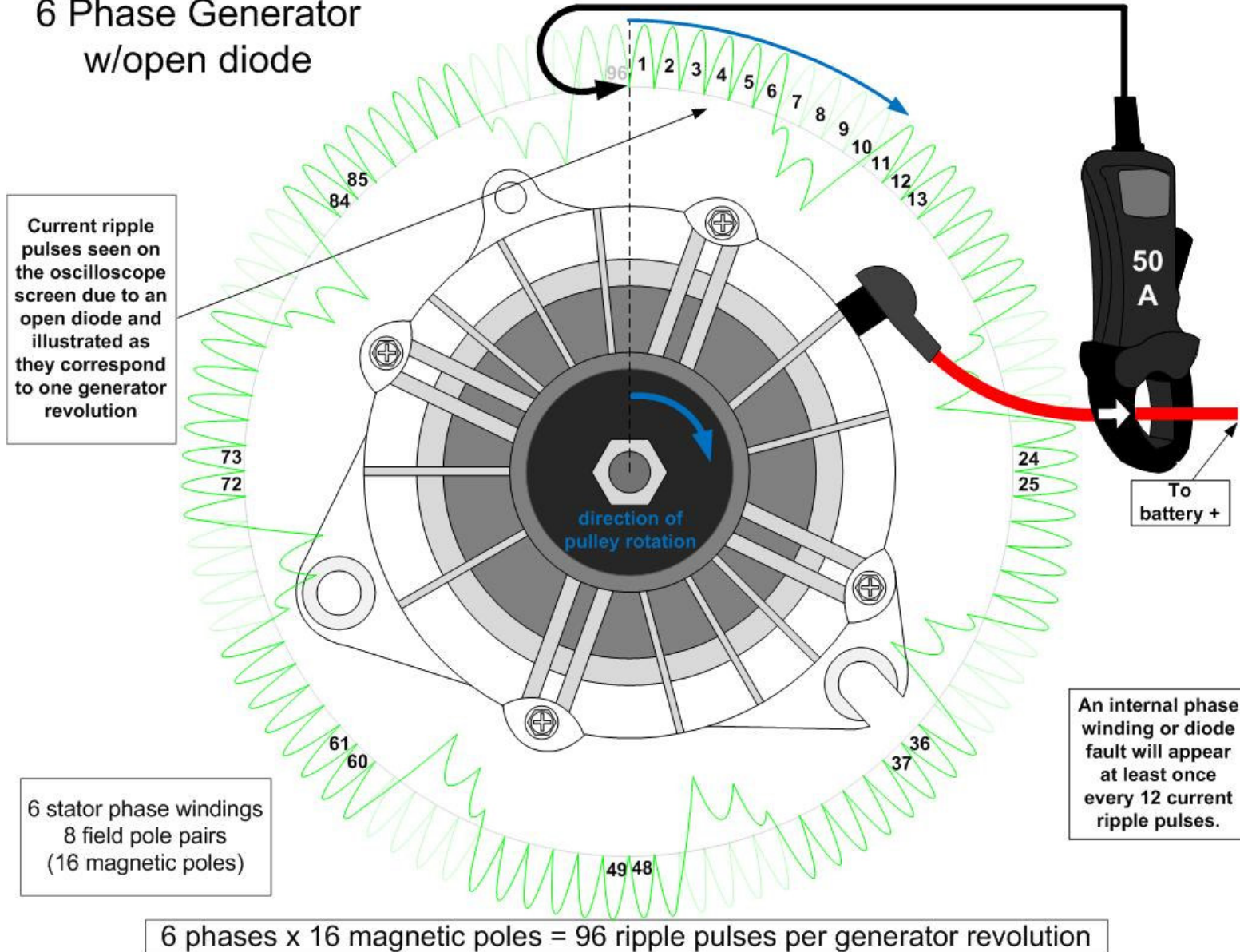

Figure 14 is the same fault (open diode) shown in relation to one generator revolution on a 6 phase 8 pole pair generator. Because the waveform is repetitive, it is not necessary to try to view all 96 pulses on the oscilloscope screen at the same time.

**Figure 14**  
6 Phase Generator  
w/open diode



A shorted diode or shorted phase will also cause a repetitive fault to be indicated in the waveform, but it will typically appear in a more noticeable fashion. It is not uncommon for the amplitude of the current waveform to be so great that the waveform goes off the top and bottom of the screen. The result will appear similar to figure 15. Again, this waveform was the result of only one diode being shorted, but the interaction of the phases affects the other ripple pulses. A shorted phase will create a very similar waveform.

**Figure 15 Shorted Diode or Shorted Phase**

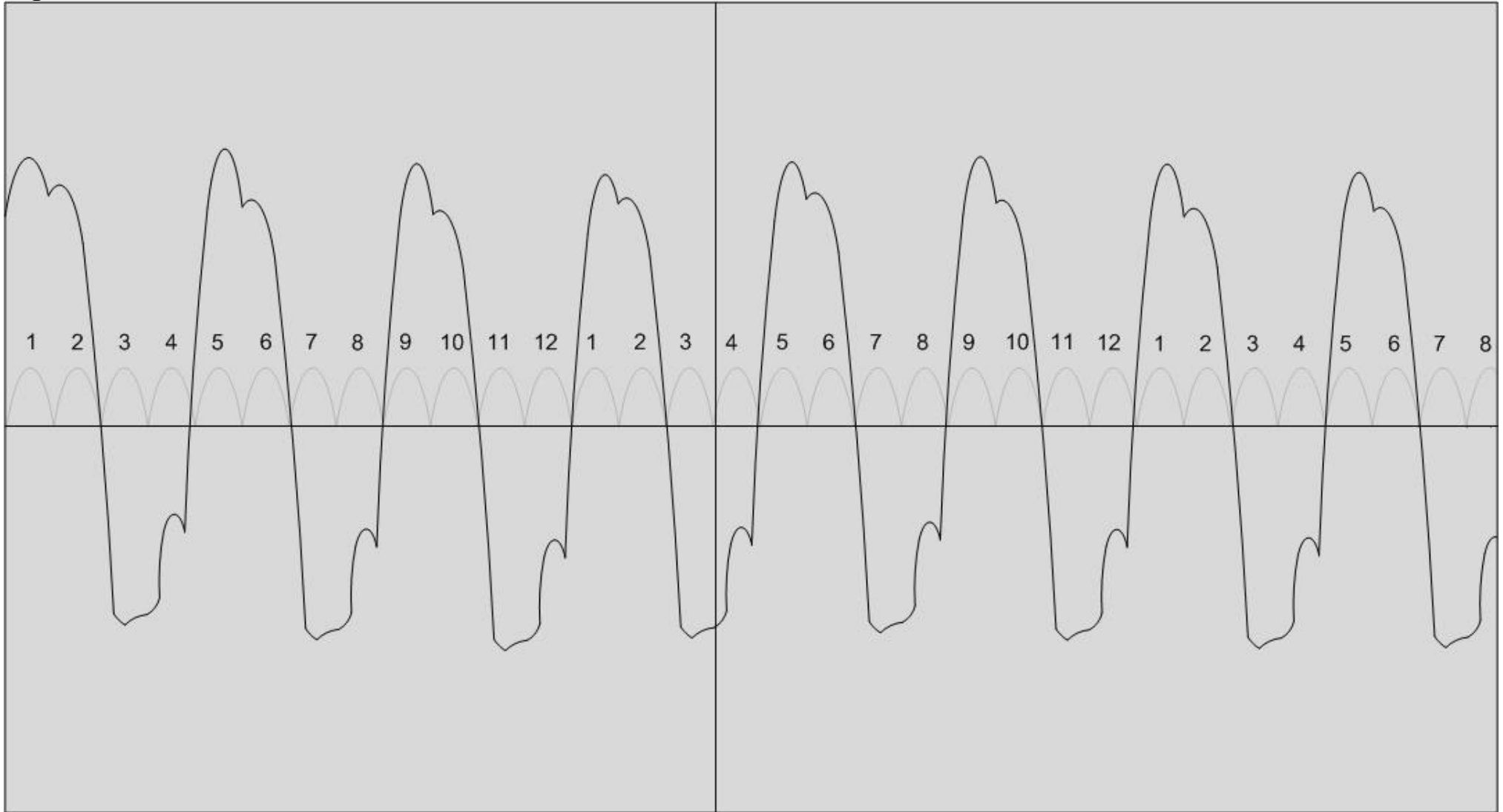
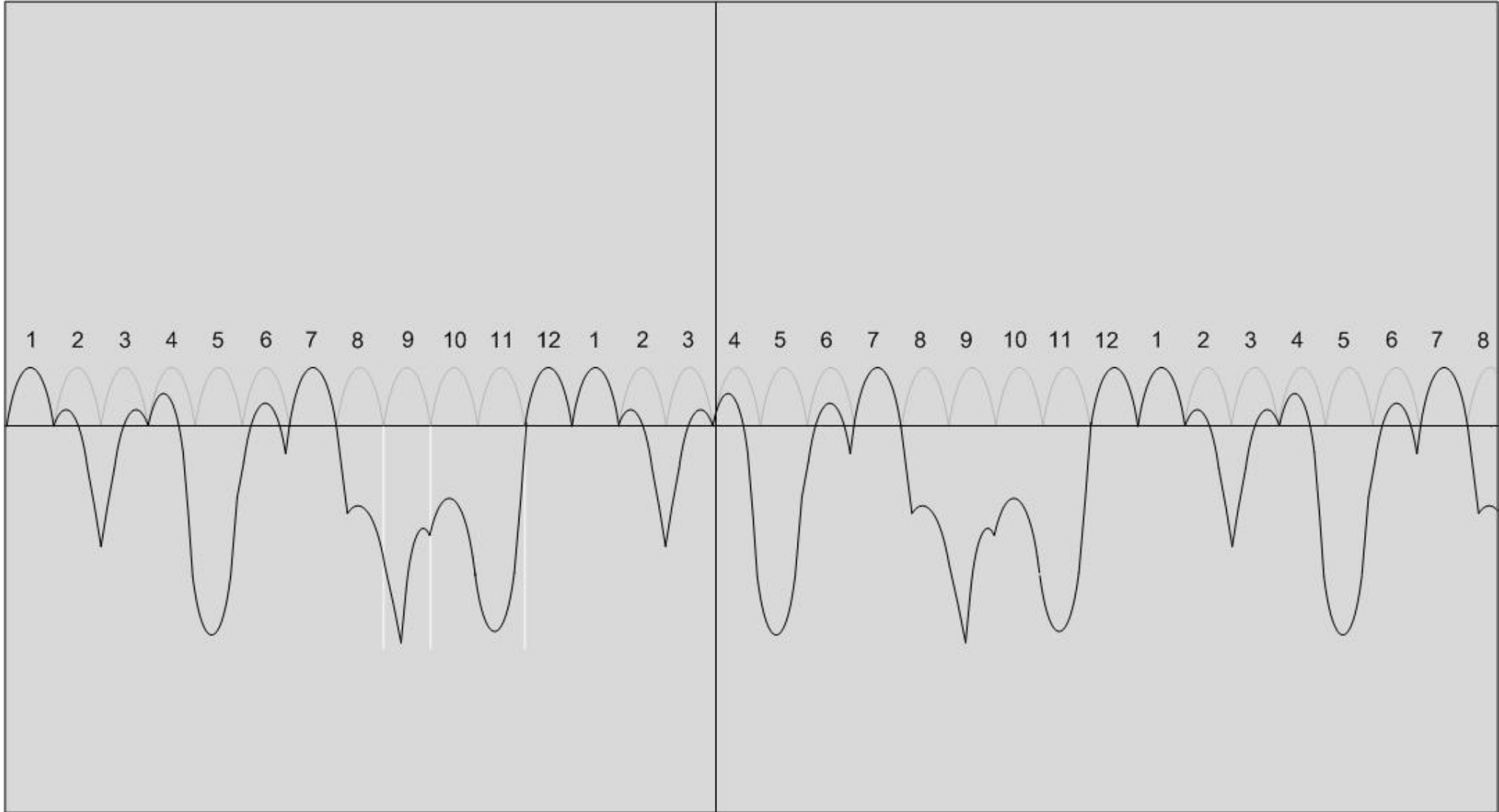

Figure 16 is an illustration of how the ripple current waveform appears when one phase winding of a 6 phase generator is open. Note that for the particular phase which was open on this generator, the primary effect was on the pulses labeled #5 and #11 (those pulses are totally absent). There is also an effect visible on the transition from pulse #2-to-pulse #3 and pulse #8-to-pulse #9. The reason that a single fault appeared to affect so many pulses of the waveform is due to the normal interaction of the phase windings.

**Figure 16 Diode Current Ripple With One Open Phase Winding**



# Factors that Influence the Appearance of Normal Generator Current Ripple

The actual diode current ripple is significantly affected by the following:

1. engine speed fluctuation
2. generator regulator duty cycle (field switching on and off)
3. the timing of the above two events (when the field is switched relative to engine speed fluctuation)
4. vehicle electrical load

Engine speed fluctuation-

Even when the engine rpm is stable, the crankshaft speed is not truly constant. As each cylinder comes up on the compression stroke, the crankshaft slows down. As each cylinder goes through a power stroke, the crankshaft speeds up. The small fluctuations in speed are multiplied by the crankshaft-to-generator pulley ratio. The end result is that the generator output fluctuates along with these changes in crankshaft speed. While viewing the current ripple on the oscilloscope, this causes the waveform to move up and down on the screen. Figure 17 shows how the engine rpm fluctuates as four cylinders go through their power stroke. Notice that the engine rpm increases (goes up) as each cylinder fires and decreases (goes down) as next cylinder comes up on compression.

**Figure 17 Engine RPM Fluctuation**

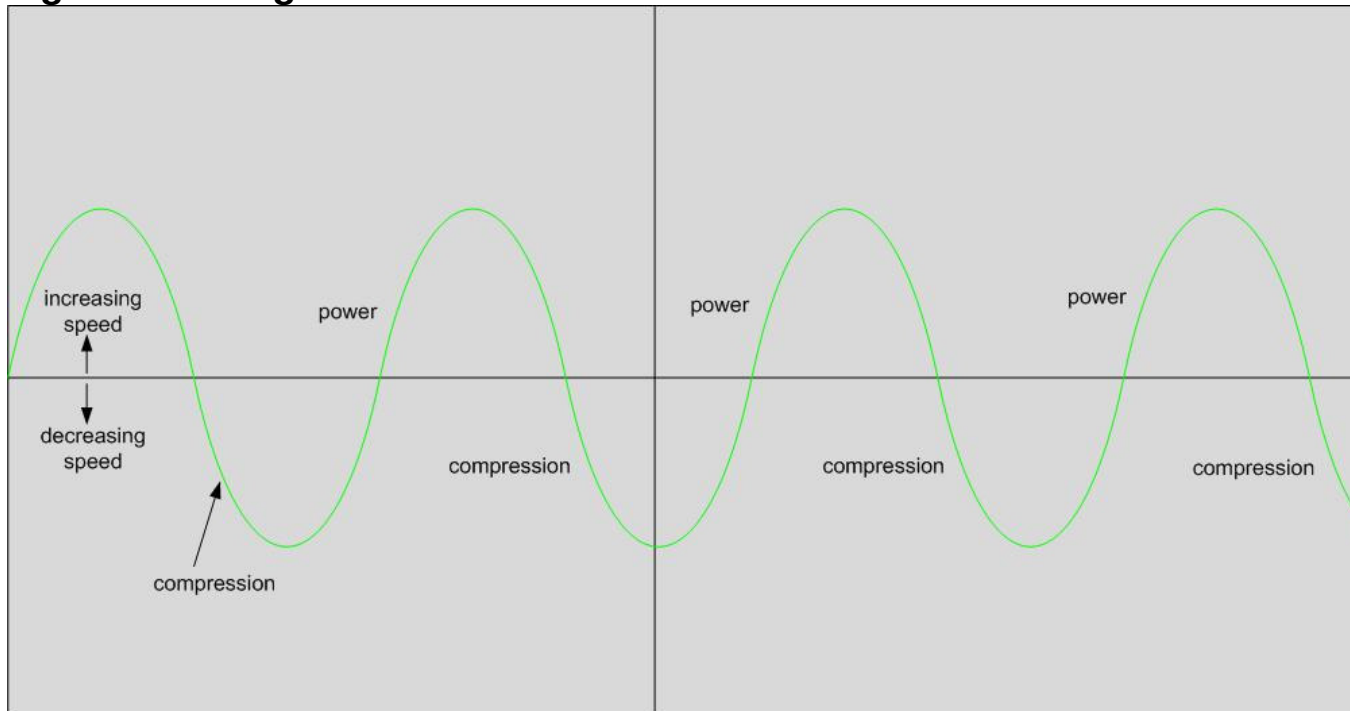

### Generator regulator duty cycle-

As the regulator switches the generator's field on and off to maintain the desired charging system voltage, the diode current ripple waveform will abruptly shift up or down on the oscilloscope screen. An example of the regulator duty cycle alone is illustrated in figure 18 (50% on time and 50% off time). When the signal is high, the generator is charging. Note that this duty cycle will change based on charging system load, battery state of charge, and PCM charging system control strategy.

**Figure 18 Regulator Duty Cycle**

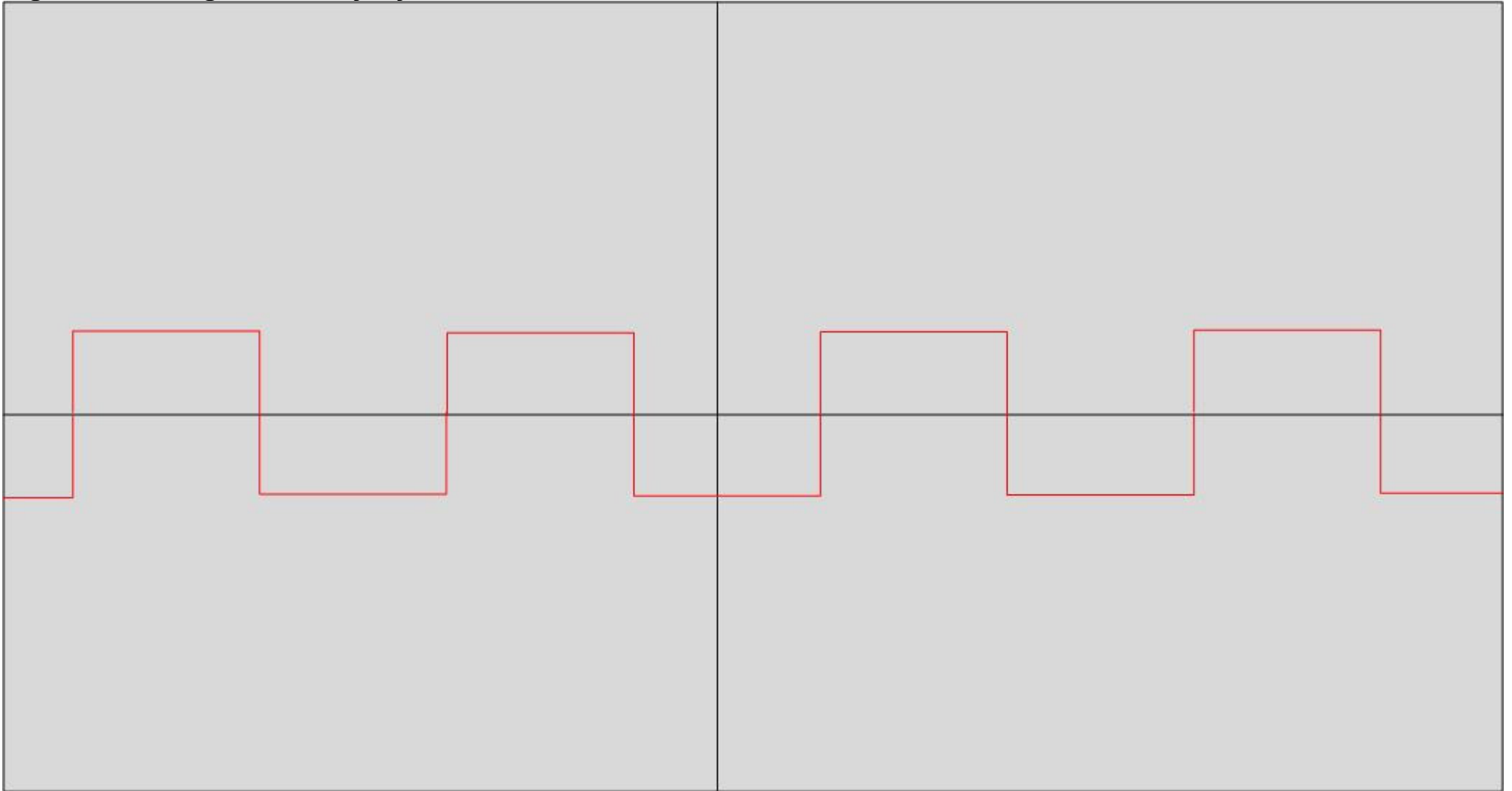



While looking at real diode current ripple, the effects of engine speed fluctuation and regulator duty cycle are a strong influence. The diode current ripple waveform that can be seen on the oscilloscope screen is a composition of all of these factors. Figure 19 indicates how the appearance of generator ripple is influenced by the crankshaft speed fluctuation and regulator duty cycle. Compare this waveform to the figure 10 illustration of theoretical diode ripple.

Again, this is a snap-shot of what normal diode current ripple might look like. Real diode current ripple will change as the regulator duty cycle changes with different electrical load and with different engine rpm. Also note that while this illustration is a "repetitive pattern", the most important fact is that the pattern does not consistently repeat every 12 pulses. (In this instance most of the illustration repeats every 16 pulses until the end when there is a slight change. Therefore, the vertical lines in this pattern do not indicate an internal generator fault. Rather the vertical lines show the normal switching on and switching off of the voltage regulator.

**Figure 19 Composition Waveform Similar to Real Diode Current Ripple Waveform**

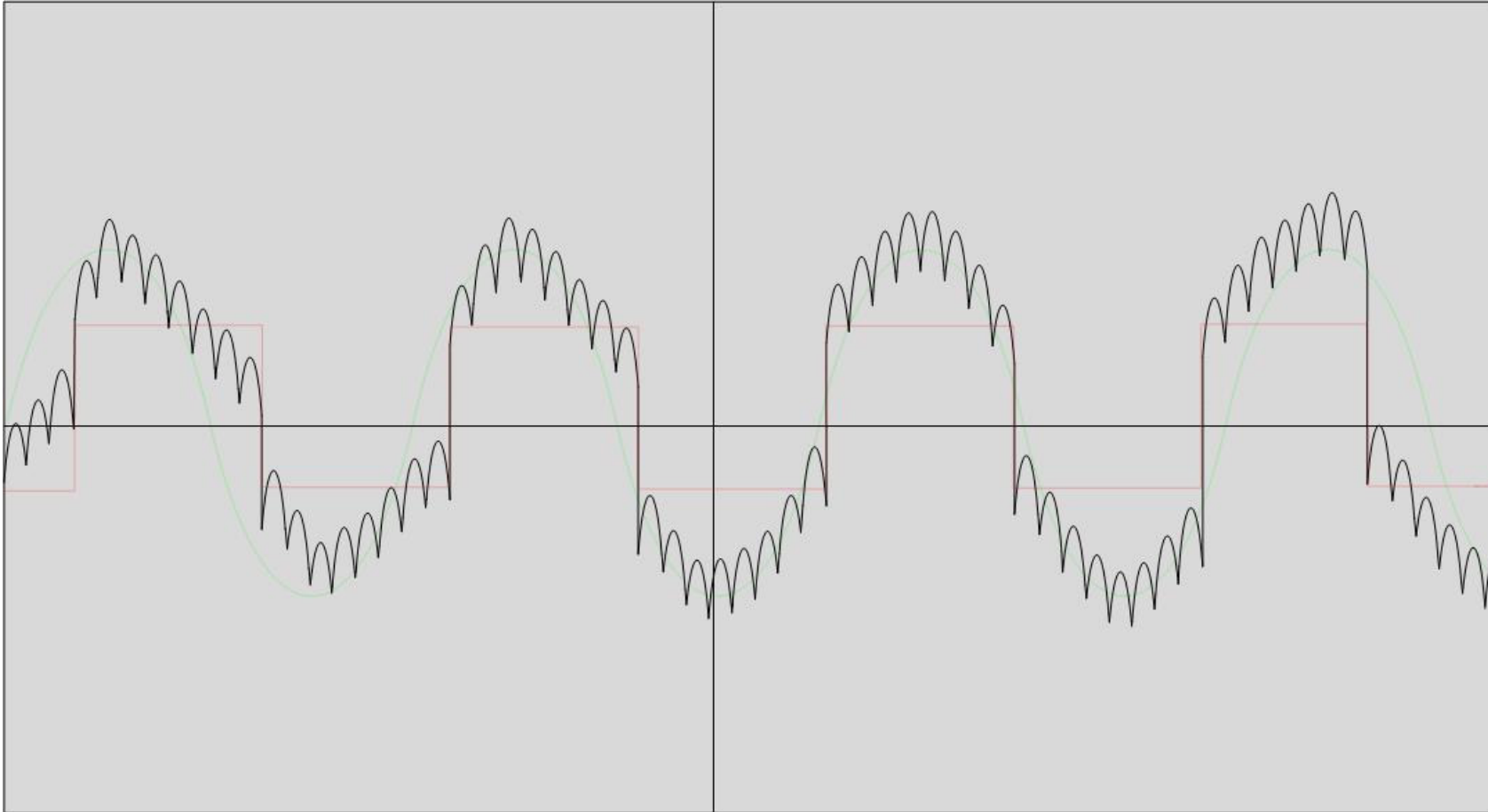

Regulator on-time is indicated when the waveform is high and off-time is indicated when the waveform is low. A valid question when reviewing figure 19 may be, "If the regulator switches the field off, how come there is still current ripple visible in the waveform?" There are several reasons for this:

1. Even though current is being reduced through the field winding, it does not completely drop to zero amps instantly. Current decreases in the field winding, but never actually drops all the way to zero before the regulator turns back on.
2. Residual magnetism in the field still causes a tiny amount of current to be generated.
3. The oscilloscope measurement trace is made using AC coupling which is more sensitive to the change in current over time and less sensitive to the overall DC current in the circuit. Therefore the ripple pattern on the oscilloscope screen for the most part remains vertically centered on the screen independent from how much DC current the alternator is producing for the vehicle.
4. Sometimes the crankshaft happens to be accelerating as the field is shut off. This results in momentarily greater ripple amplitude than would otherwise be seen.

It is important to know that figure 19 is not perfect and is only a general illustration.

Figure 20 is another illustration of generator ripple which shows some of the normal characteristics likely to be seen when viewing the waveform on a real vehicle. Depending upon exactly when the regulator turns on and off, sometimes a ripple pulse gets cut in half (blue arrows) or may show some "ringing" (green arrows) due to normal electrical behavior. These conditions are normal and do not by themselves indicate a fault. The "ringing" that is illustrated in figure 20 is exaggerated for easier viewing.

Note that the regulator on/off duty cycle and engine rpm fluctuation are still indicated in the background of figure 20 to clarify how the waveform is being influenced. These signals are not usually accessible when looking at generator ripple on a vehicle. Therefore it is important to understand how to recognize their normal effects on the diode current ripple waveform.

Figure 20 also indicates how the effect of the regulator switching on and off can be more or less pronounced depending upon when the switching occurs with respect to engine rpm fluctuation. For example, if the regulator turns on as the crankshaft is accelerating, the ripple waveform tends to "jump" upward suddenly whereas if the regulator turns on when the crankshaft is decelerating, the ripple waveform does not jump upward significantly. The opposite is true when the regulator turns off. In other words, the regulator duty cycle affects the current ripple waveform to varying degrees depending upon if the crankshaft is accelerating or decelerating at the time when the regulator switches on or off (indicated by purple arrows). Therefore, the vertical lines that are visible in the waveform due to regulator switching do not indicate a fault even if they appear to suddenly vary in amplitude.

**Figure 20 Normal Current Ripple Waveform Showing Normal Effects of Regulator Switching and RPM Fluctuation**

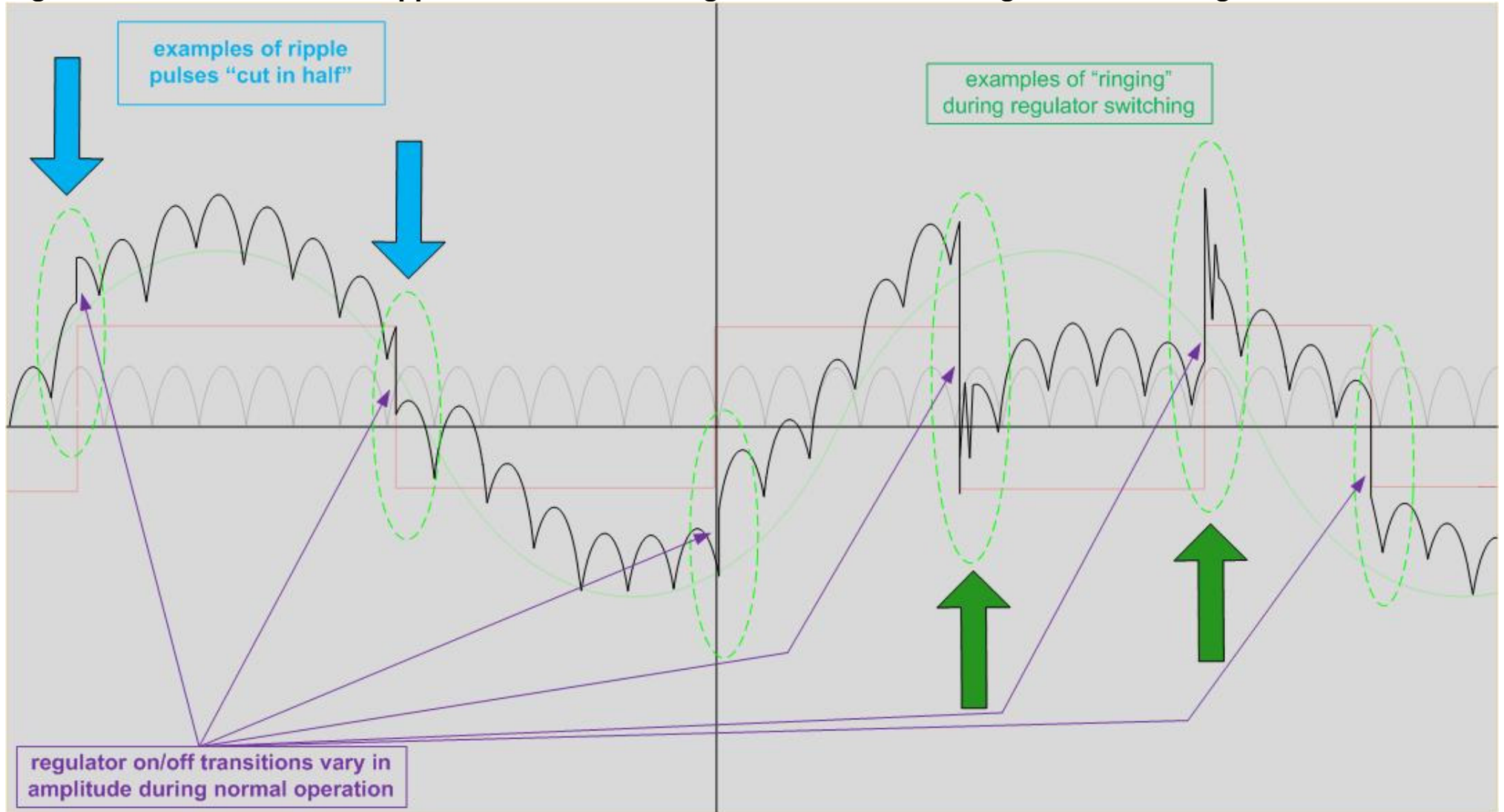

The amplitude of the diode current itself changes with respect to charging system load. The greater the vehicle electrical load, the greater the amplitude of the diode current ripple. Figure 21 illustrates this.

**Figure 21 Heavy Charging System Load Causes Higher Diode Current Ripple Amplitude**

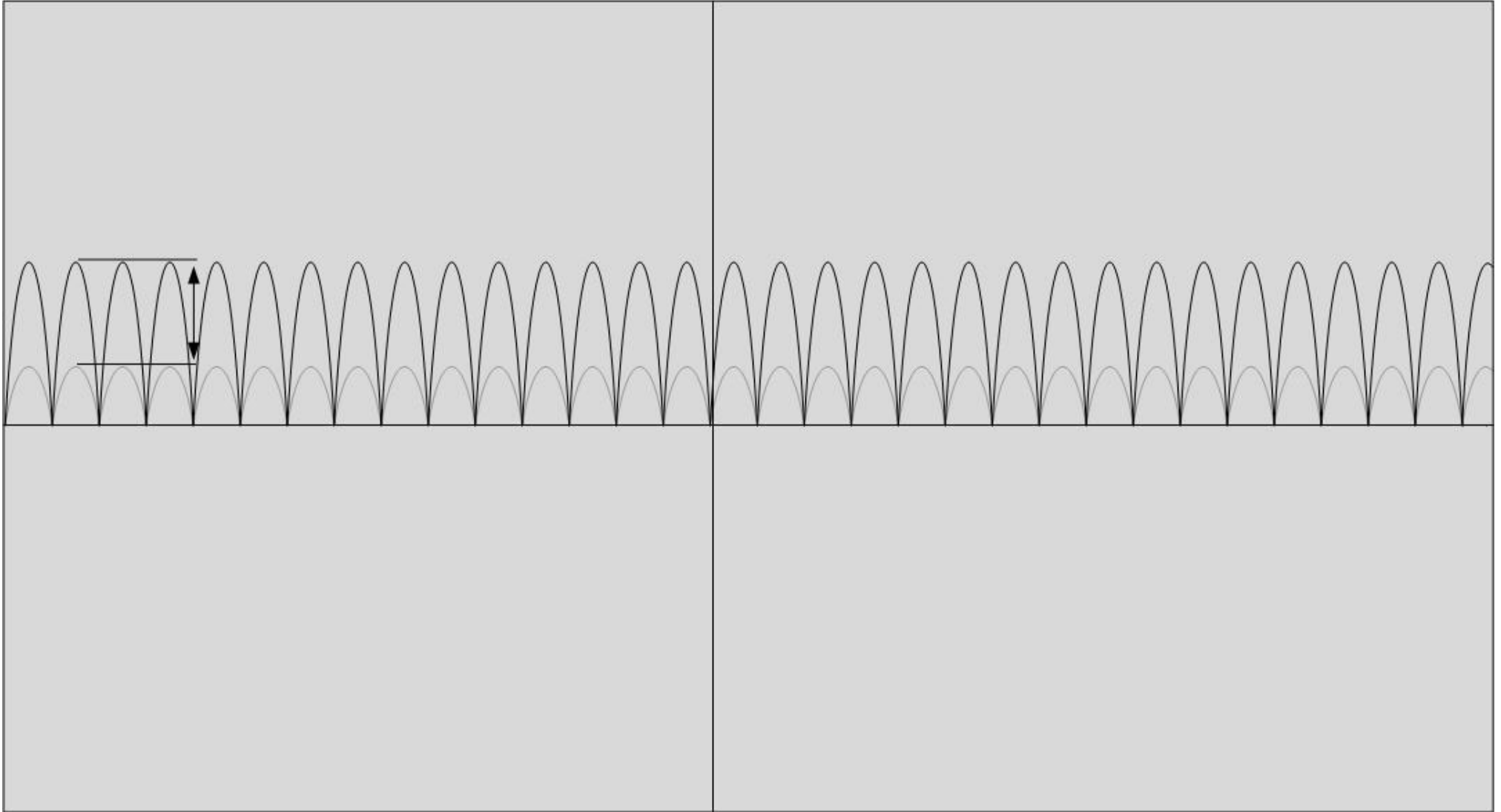

It is possible that while monitoring diode current ripple, the total amount of generator output current will sometimes be greater than what the 50 amp probe can measure. For example, if generator output exceeds 50 amps of DC current, the current ripple being viewed on the oscilloscope screen may be out of the probe's range of measurement. If this is the case, the waveform will appear to flat-line intermittently as shown in figure 22. Under extreme charging system load, generator current ripple may disappear completely (oscilloscope trace goes to 0). This does not indicate a fault. Instead of using the 50 amp probe, connect the 500 amp probe and manually select the Sense – 500 A probe, Scale - 5 amps/division, and Coupling - AC to obtain the necessary measurement range if the charging system must be tested under extensive load to duplicate a concern.

**Figure 22 Normal Ripple Current Showing Clipping (normal with 50 amp probe at high charging system load)**

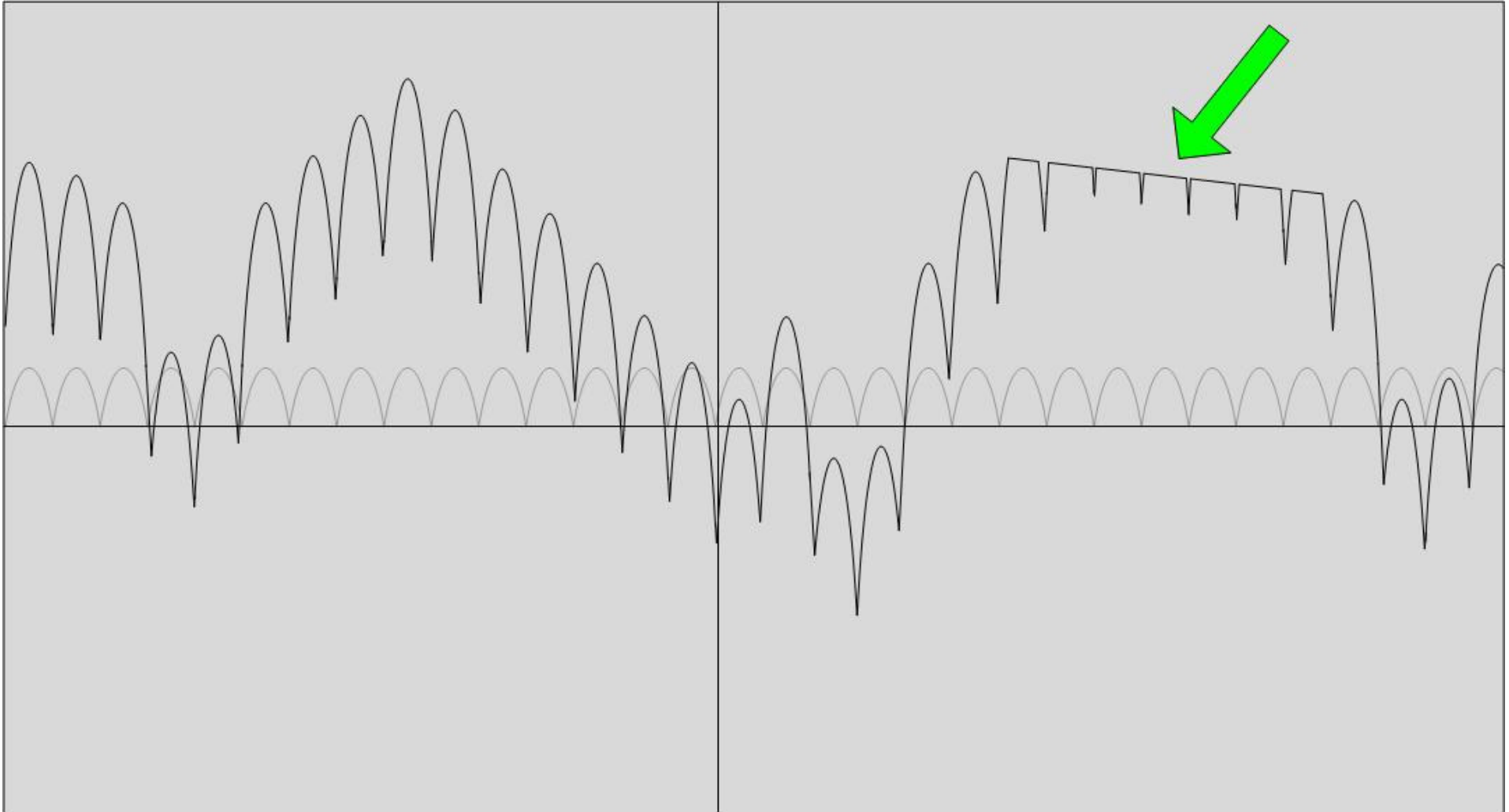

## Examples of Normal Current Ripple Waveforms

Figure 23 is an example of normal generator current ripple. Close observation reveals that the ripple pulses seem to have an "every-other-one" difference in amplitude (indicated with blue lines). This is a normal characteristic of some 6 phase generators under certain operating conditions and is due to the type of winding design. Also, the regulator switching can be seen (indicated with yellow arrows).

Figure 23

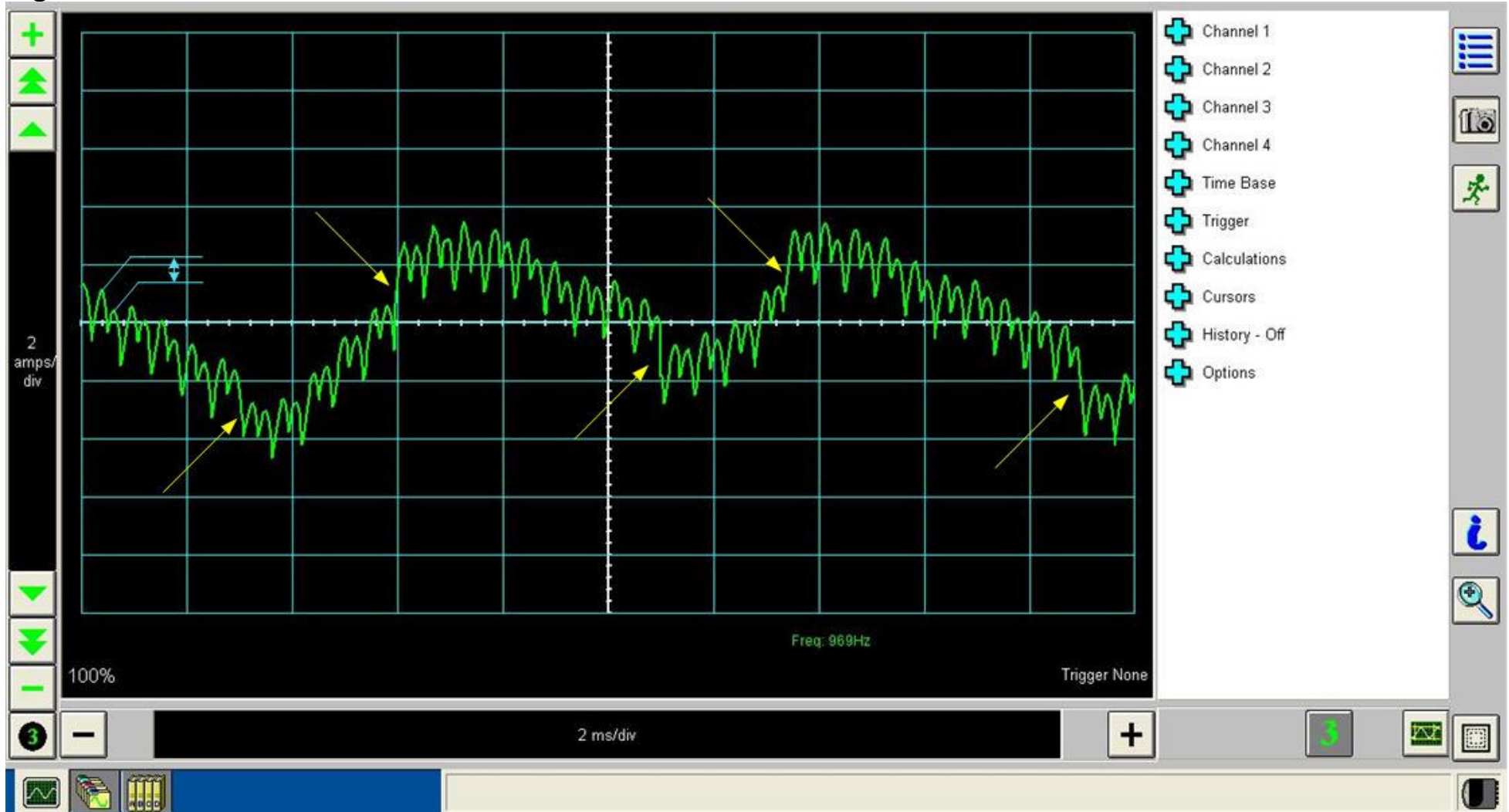

Figure 24 is another example of normal generator current ripple. Can you pick out regulator switching events?

**Figure 24**



Figure 25 is the same waveform as in figure 24, but with the RPM fluctuation and regulator switching events illustrated for reference.

**Figure 25**





The waveform in figure 26 indicates another normal characteristic that may be seen when viewing diode current ripple. The waveform shows clipping (circled in white). This does not indicate any fault. It simply means that the current being measured is exceeding the measurement capability of the 50 amp probe. This can be eliminated by manually switching over to the 500 amp probe and changing the oscilloscope to 5 amps/div and AC coupling. Normal regulator switching is indicated by the yellow arrows.

**Figure 26 Normal Waveform With Minor Clipping**

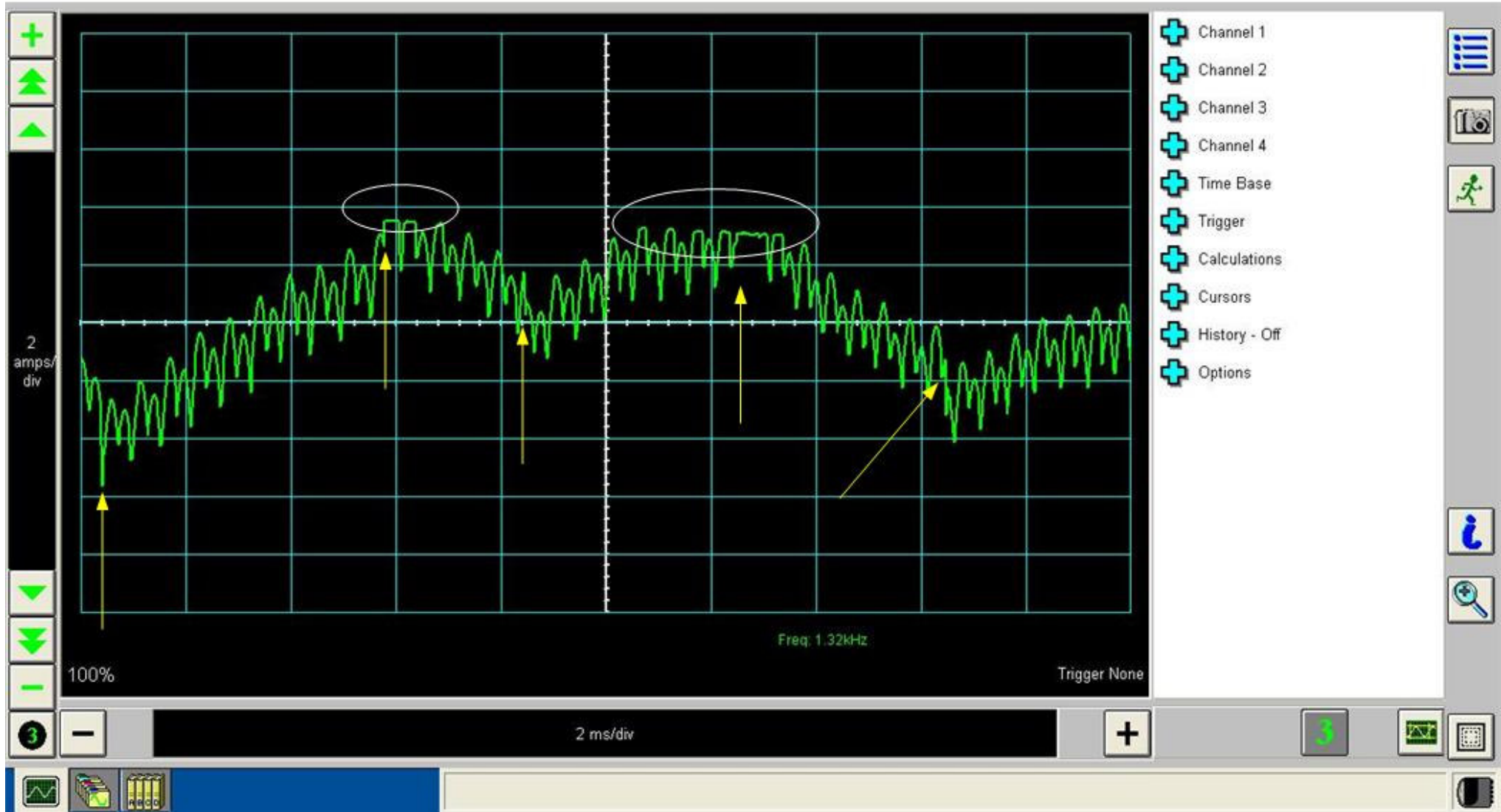
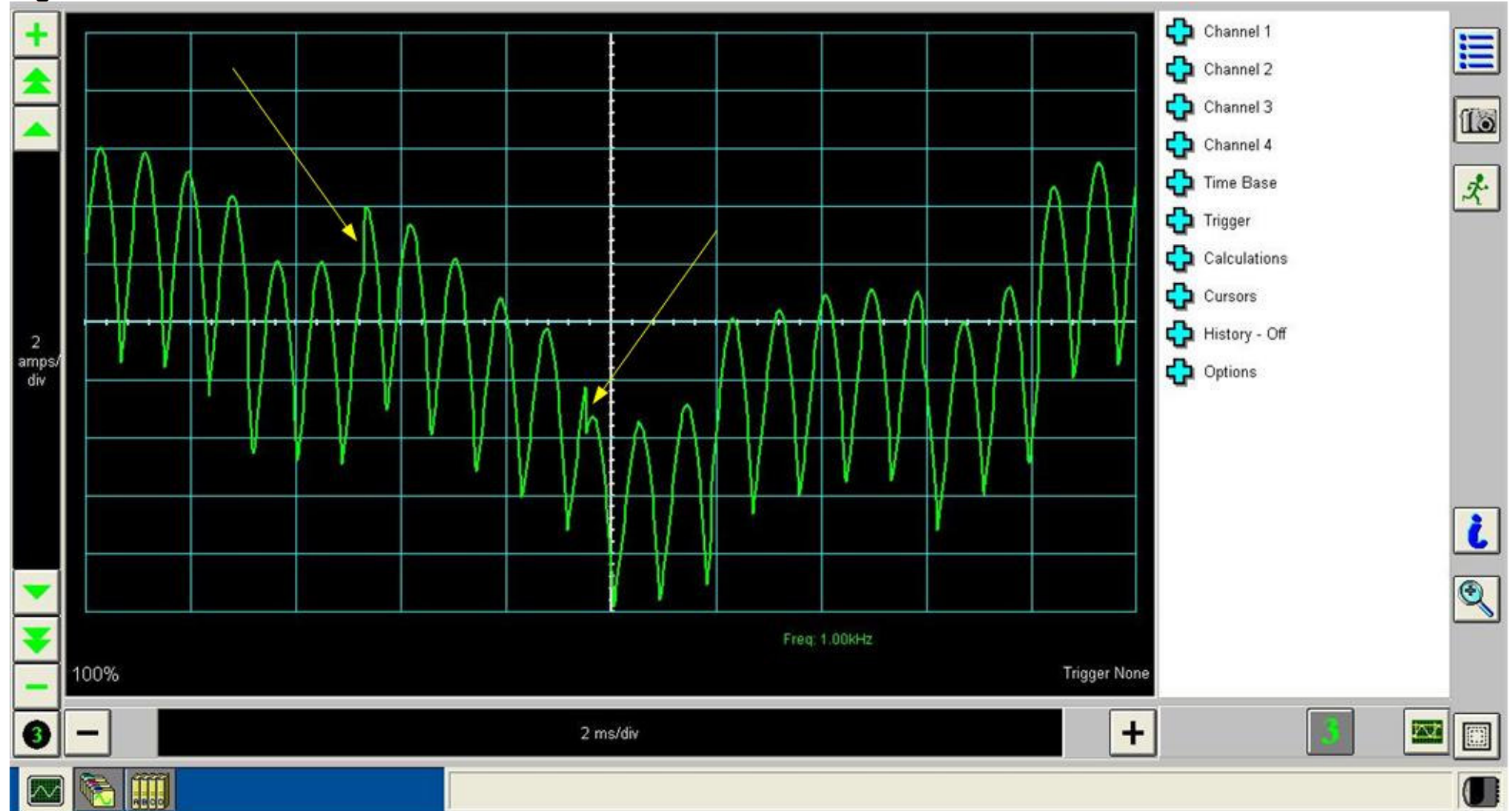

Figure 27 is an example of normal diode current ripple from a 3 phase generator. The effect of regulator switching is pointed out with the yellow arrows.

Figure 27



Another example of normal diode current ripple is shown in figure 28. Notice how the tops of the ripple pulses are distorted (appear to have a dimple instead of being rounded like the top of an umbrella). This is a characteristic of some generator designs and does not indicate a fault.

The orange colored trace in the background is generator voltage ripple at the battery. Voltage ripple amplitude is much smaller and more difficult to distinguish from other vehicle electrical activity.

**Figure 28**

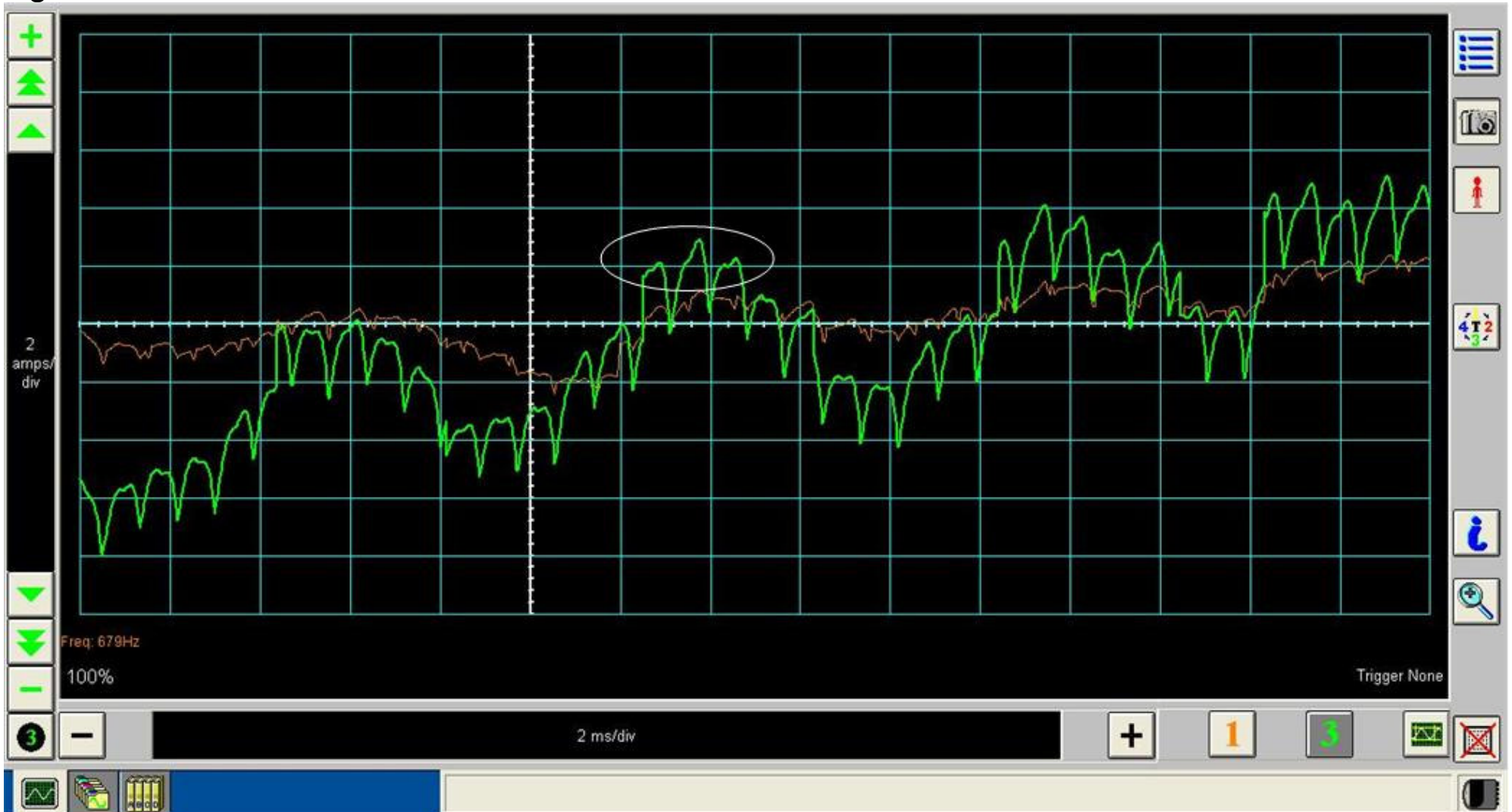
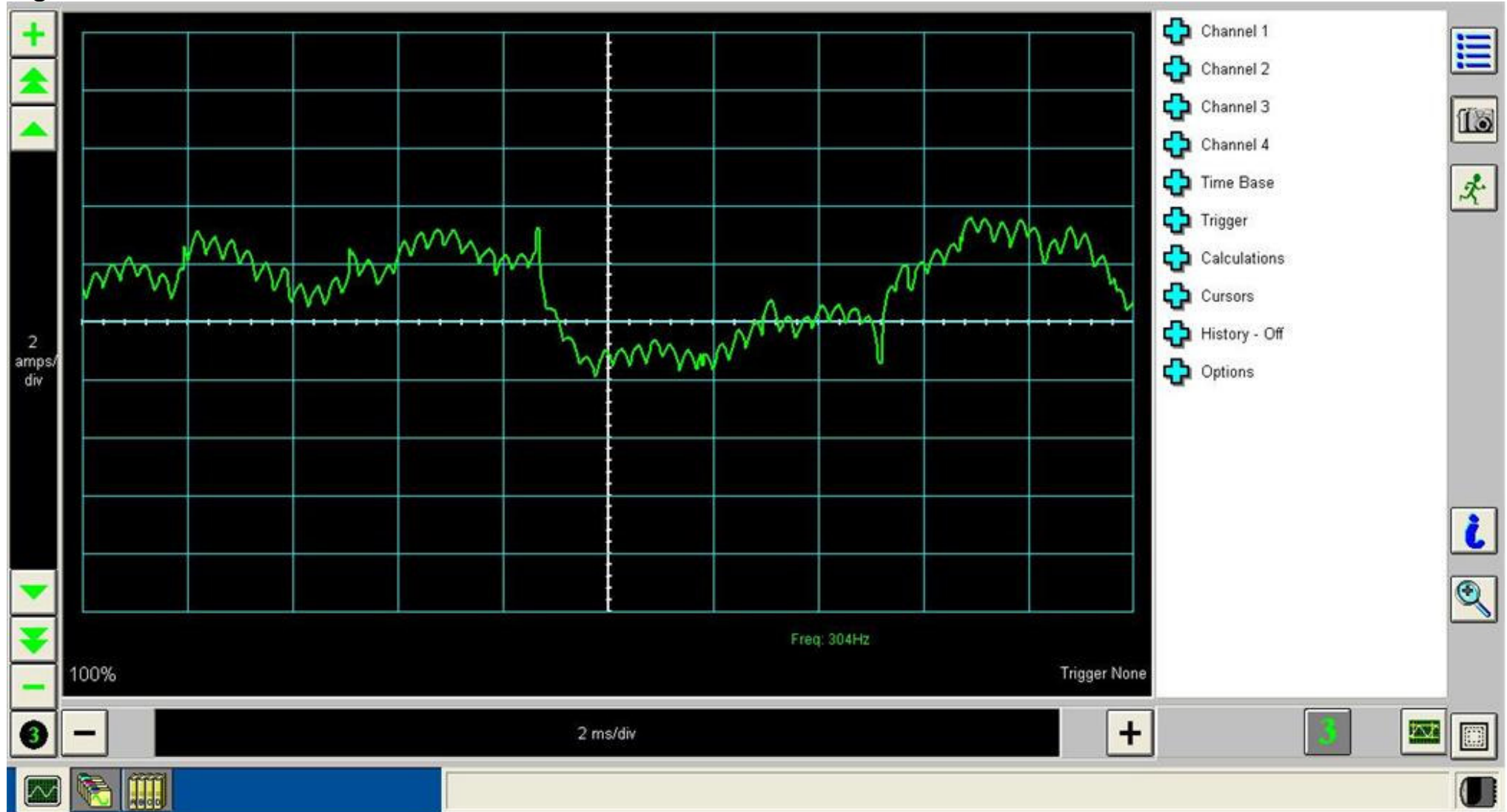

Figure 29 is a waveform from a dual generator vehicle, but the current probe was accidentally placed on the positive cable at the battery junction box instead of being properly placed on the B+ output cable from the generator. Even though there appear to be suspicious positive and negative spikes, they do not indicate an internal generator fault because they are not part of a repetitive 12 pulse pattern. In this case the spikes are from normal vehicle electrical activity. If the current probe were properly placed, the spikes would not be present.

**Figure 29**

## Examples of Faulted Current Ripple Waveforms

Figure 30 is a waveform from a generator with an open diode. The key observation is that the pulses in the lower portions of the waveform are wider than those of the upper pulses. It is this fact (that the pulses suddenly get wider) combined with the observation that this pattern is repetitive (every 12 pulses) that allows the conclusion to be made that there is an internal generator fault. The yellow arrows point out normal regulator switching. Regulator switching can make it difficult to count ripple pulses, but as pointed out in figure 20, it is usually possible to determine when a ripple pulse gets cut in half by a regulator switching event. The diode pulses are numbered in the same scheme as in figure 13. Compare this waveform to the illustration of an open diode pattern in figure 13 to see the similarities.

By continuing to count the ripple pulses in this waveform, it can be seen that the pattern repeats every 12 pulses.

**Figure 30 Open Diode**



38  
Figure 31 is another example of an open diode.

**Figure 31 Open Diode**

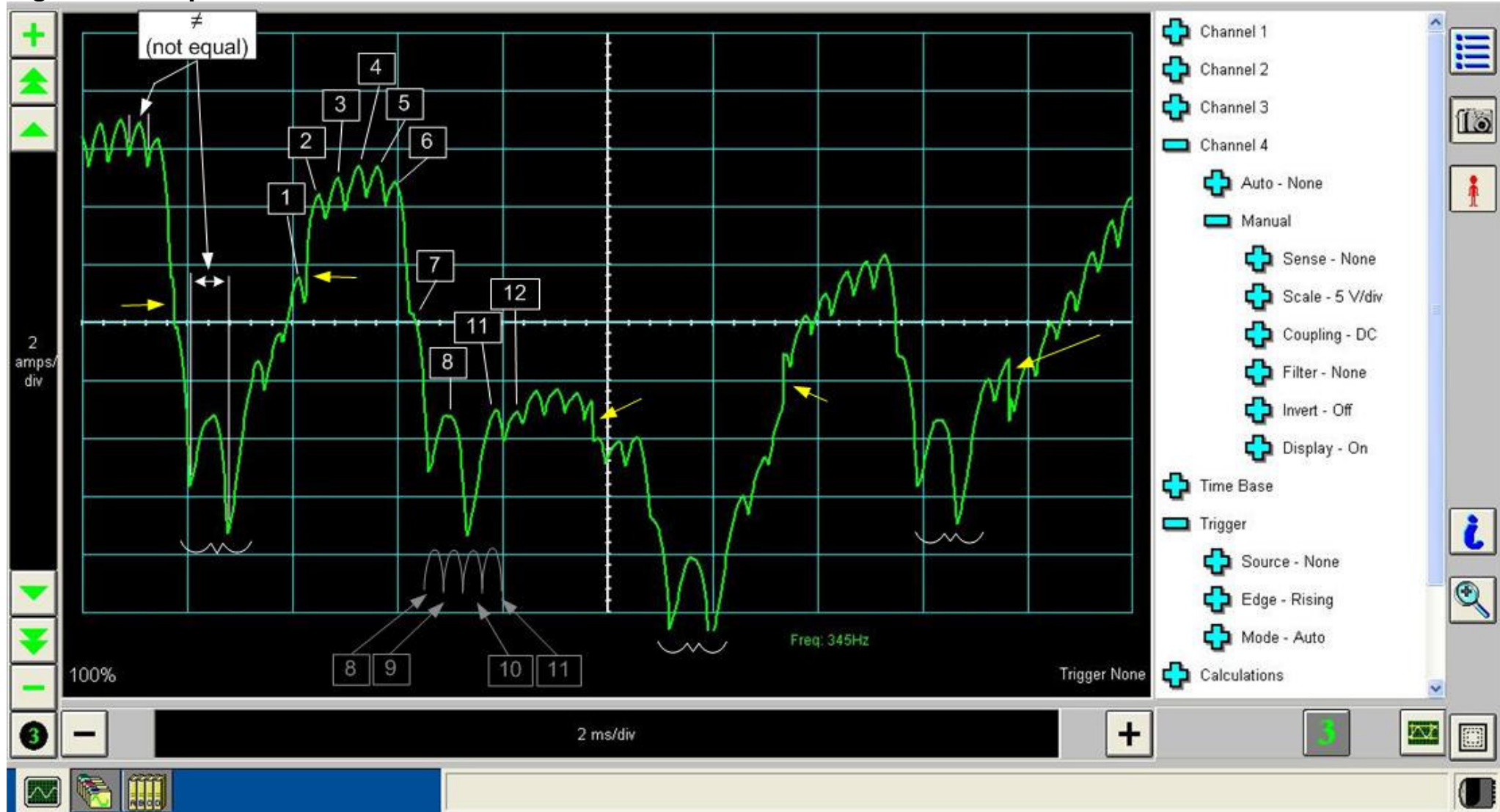

A shorted diode waveform is shown in figure 32. The current waveform grows so much in amplitude that it goes off the top and bottom of the screen. The setting of 2 amps/div could be changed to 5 amps/div in order to make the waveform peaks and troughs viewable if desired. A shorted phase will produce a very similar waveform.

**Figure 32 Shorted Diode Normal Settings**

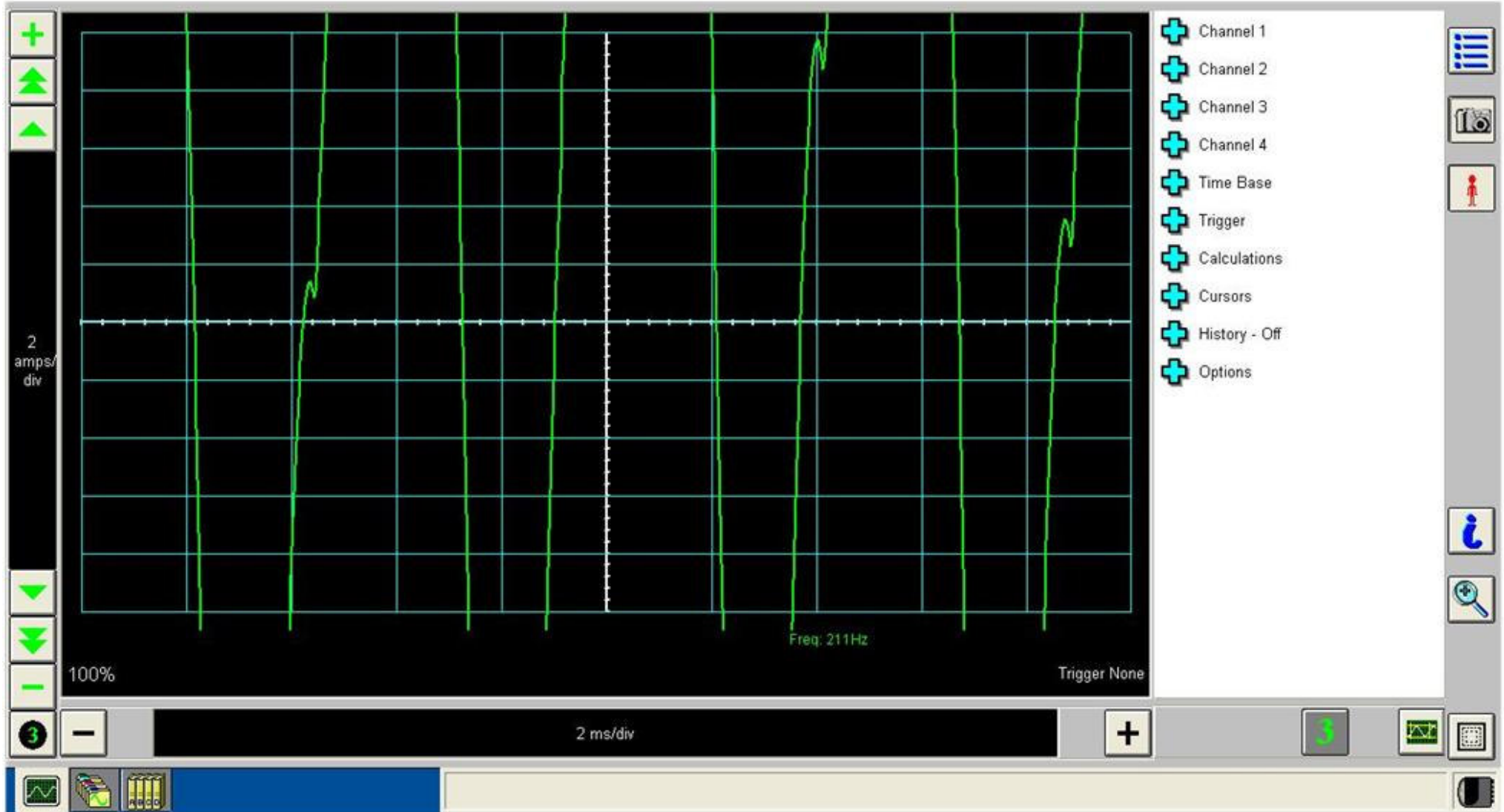

Figure 33 is a waveform indicating an open phase or stator winding. Though the waveform may appear to be random, there is a repeating 12 pulse pattern. The pulses are labeled in black in the same manner as figure 16. The missing pulses (#5 and #11) and the transition areas (pulse #2-to-pulse #3 and pulse #8-to-pulse #9) are illustrated in gray to clarify the pulse count. Pulse #7 was stretched vertically due to the regulator switching on (note vertical line at upper left portion of the #7 pulse). One way of beginning to analyze this waveform is to look at the largest negative going pulses (#5 and #11). If an open phase is the root cause, the large negative going pulses will happen every 6th pulse (for a 6 phase generator).

**Figure 33 Open Phase**

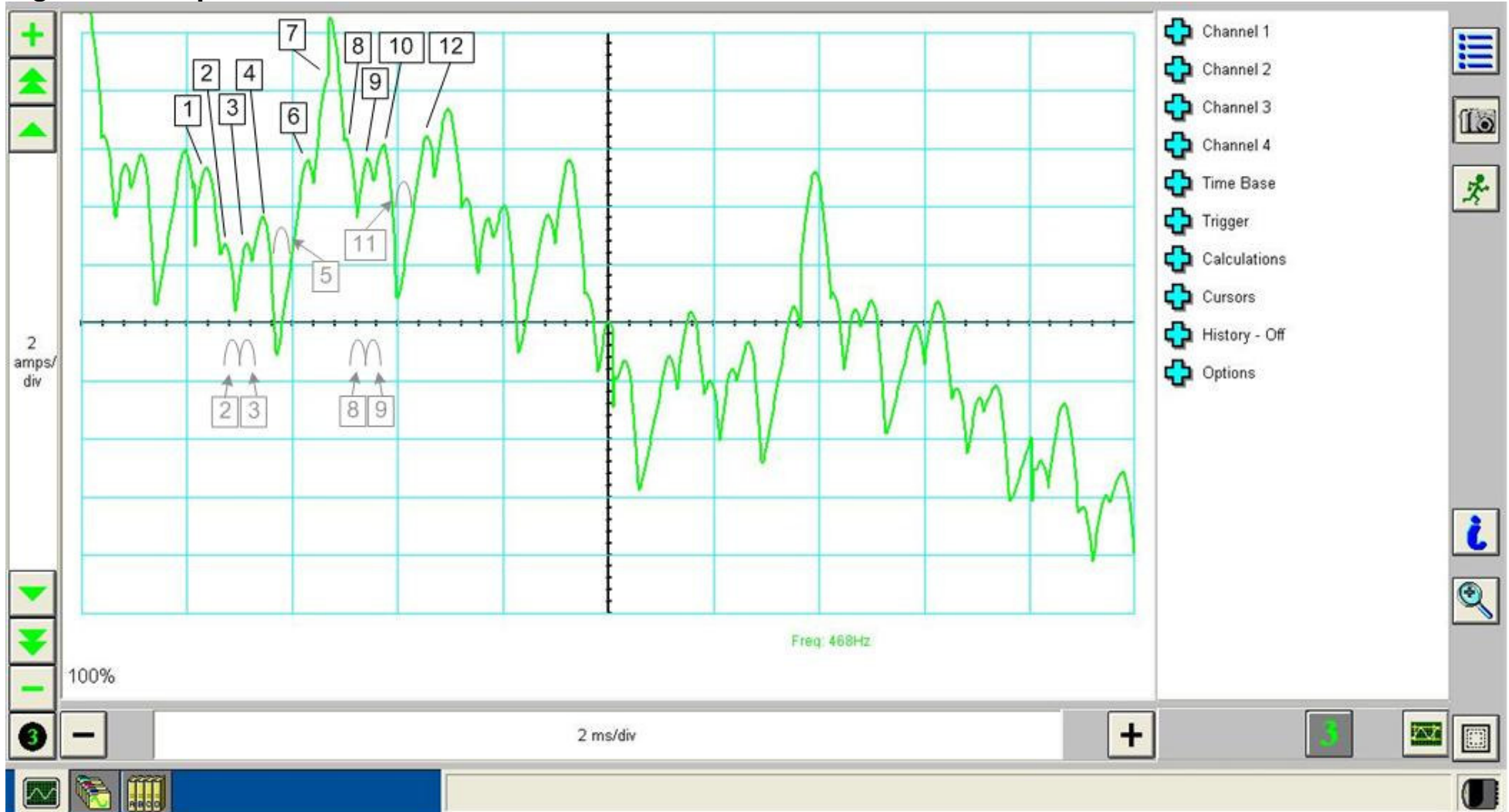



Figure 34 is another example of an open phase with pulses numbered.

**Figure 34 Open Phase**

